

LV Model Water Source Heat Pump

1/2 to 6 ton

The option-rich, water-to-air LV offers one of the smallest cabinets in the industry, making it a great choice for replacement and new construction projects.

LV MODEL	UP TO	UP TO
	16.9 EER GLHP	5.3 COP WSHP



Made in
the U.S.A.



Commercial Sales Catalog
boschheatingandcooling.com



BOSCH
Invented for life

Table of Contents

MODEL NOMENCLATURE	2	Geothermal Systems	17
CERTIFIED PERFORMANCE DATA	3	Earth Coupling Options.....	17-18
FHP EQUIPMENT	5	Vertical Ground Loop System.....	18
ADVANTAGES OF FHP’s TECHNOLOGY	5	Horizontal Ground Loop System	18
LV MODEL 007-070	5	Surface Water, Lake or Pond System	19
FEATURES, FUNCTIONS AND BENEFITS	5-7	Well Water System.....	19
Cabinet.....	5	TYPICAL HEAT PUMP OPERATION	19
Quiet Operation	6	Cooling Mode.....	19
Serviceability	6	Heating Mode.....	19
Unit Configurations.....	6	TYPICAL UNIT INSTALLATION	20
Filter Racks and Options	6	Water-to-Air Heat Pump Cycle - Cooling.....	20
Optional MERV-8 and -13 Filter	6	Water-to-Air Heat Pump Cycle - Heating.....	20
FAN MOTOR	7	Unit Location.....	20
Permanent Split Capacitor Motors (PSC).....	7	Vertical Unit Installation	20
ECM Constant Torque Motor (Optional).....	7	Horizontal Unit Installation	21
ECM Constant Airflow Motor	7	Ductwork & Sound Attenuation Considerations....	21
Hanging Brackets.....	7	Piping.....	22
Water Connections	7	Condensate Drain Piping.....	22
Two-Position Water Valve.....	7	Operating Limits – Cooling & Heating	22-23
Refrigerant Circuit	7	EQUIPMENT SELECTION	23
Evaporator Coil and DuoGuard™	8	ANTIFREEZE CORRECTION DATA	24
Blower Housing.....	8	WATERSIDE PRESSURE DROP	24
Unit Protection Module	8-9	CAPACITY DATA	25-37
UPM CONTROL BOARD FEATURES	9-10	LV007 (300 CFM)	25
ADDITIONAL OPTIONS	10	LV009 (350 CFM)	26
Hot Gas Reheat.....	10	LV012 (400 CFM).....	27
Hot Gas Reheat Control Options	11	LV015 (500 CFM).....	28
Special Considerations.....	11	LV018 (650 CFM).....	29
Low Temperature Well Water	11	LV024 (850 CFM).....	30
Indoor Pool Dehumidifying During Winter Months...11		LV030 (950 CFM).....	31
Sequence of Operation - Modulating		LV036 (1200 CFM).....	32
Hot Gas Reheat (MHGRH).....	11	LV041 (1150 CFM).....	33
Hot Gas Bypass.....	11	LV042 (1500 CFM).....	34
Psychrometric Chart.....	12	LV048 (1600 CFM).....	35
DDC Controls	12	LV060 (2000 CFM).....	36
DDC Room Sensors	12	LV070 (2200 CFM).....	37
DDC Zone Sensors	13	UNIT ELECTRICAL DATA	38
Waterside Economizer Common Waterside		Standard Blower Motor	38
Economizer Applications.....	13	ECM Constant Torque	39
Fluid Flow	13	ECM Constant Airflow (Variable Speed).....	40
Aquastat.....	14	BLOWER PERFORMANCE CFM	41
Air Side Pressure Drop	14	Standard Blower Motor	41
Fluid Differential Pressure Switch.....	14	ECM Constant Torque	42
Energy Management Switch (EMS)	14	ECM Constant Airflow (Variable Speed).....	43
OTHER OPTIONS	15	PHYSICAL DATA	44
ACCESSORIES	15	HORIZONTAL CABINET CORNER WEIGHTS	45
Thermostats.....	15	VERTICAL UNIT DIMENSIONS	46
Hose Kits.....	15	HORIZONTAL UNIT DIMENSIONS	47
UNIT CONFIGURATION DIAGRAMS	16	COUNTERFLOW UNIT DIMENSIONS	48
SYSTEMS	17	GUIDE SPECIFICATION	49-52
Water Source Cooling Tower/Boiler Systems	17		

Model Nomenclature

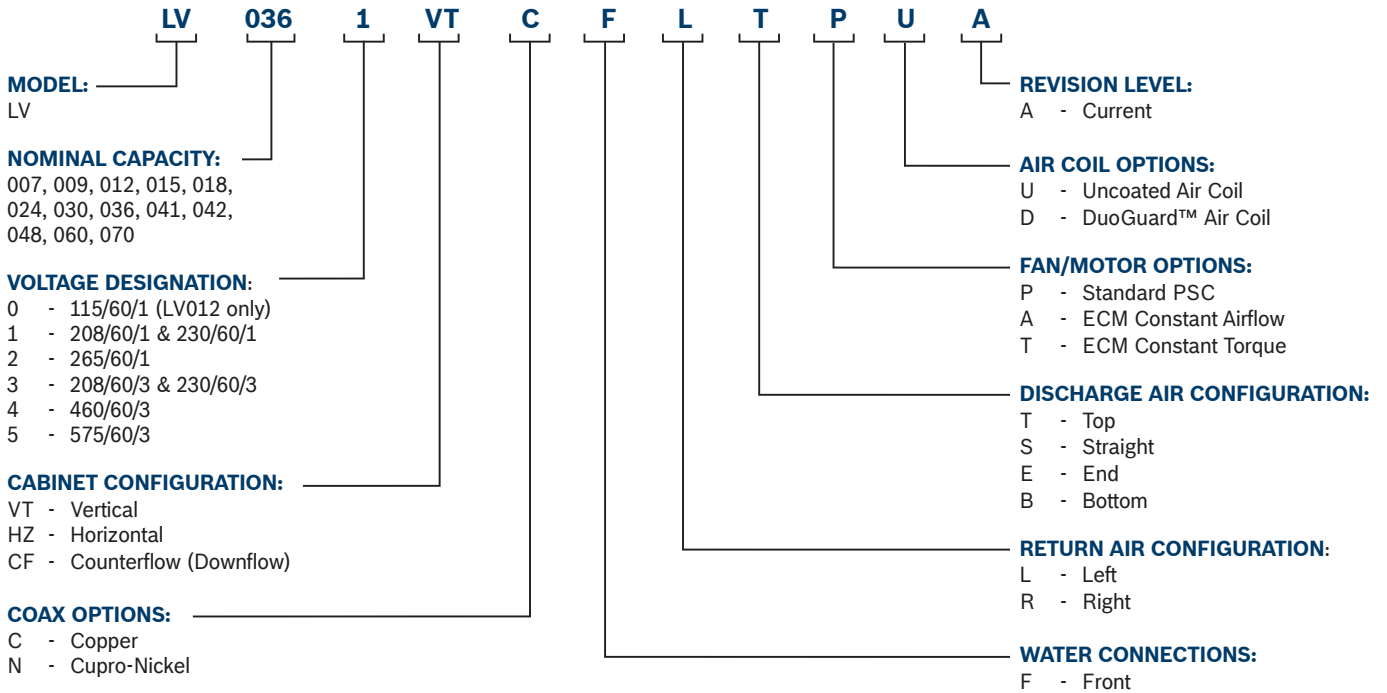

Certified Performance Data

Model	Fluid Flow Rate	AHRI/ANSI 13256-1 Performance Data							
		Entering Water Temperatures							
		86 °F		68 °F		77 °F		32 °F	
		Water Loop				Ground Loop			
		Capacity and Efficiency Data – PSC motor with TXV							
		Cooling Capacity (WLHP)	EER (WLHP)	Heating Capacity (WLHP)	COP (WLHP)	Cooling Capacity (GLHP)	EER (GLHP)	Heating Capacity (GLHP)	COP (GLHP)
LV007	2.0	6,100	12.20	7,800	5.30	6,800	15.10	4,900	3.40
LV009	2.5	8,200	12.40	9,900	4.70	8,700	14.60	5,740	3.20
LV012	3	10,900	12.20	13,000	4.30	11,800	14.10	8,700	3.20
LV015	4	14,200	12.80	16,100	4.40	14,200	14.60	11,300	3.30
LV018	5.0	19,400	13.40	22,200	4.60	21,200	15.80	14,300	3.50
LV024	6	23,400	13.40	26,600	4.40	25,000	15.50	17,000	3.40
LV030	7	29,200	13.20	33,400	4.30	31,000	14.70	20,900	3.30
LV036	9	37,900	14.15	41,800	4.60	39,900	16.90	26,900	3.50
LV041	9	39,500	13.10	44,600	4.30	41,200	14.30	29,400	3.20
LV042	10	40,000	13.70	46,300	4.30	42,600	14.80	31,000	3.30
LV048	12	45,900	13.00	56,400	4.30	48,800	14.90	35,400	3.40
LV070	16	64,000	13.30	72,800	4.40	66,400	15.00	50,800	3.40

Model	Fluid Flow Rate	AHRI/ANSI 13256-1 Performance Data			
		Entering Water Temperatures			
		86 °F		68 °F	
		Water Loop			
		Capacity and Efficiency Data – PSC motor with capillary tube			
		Cooling Capacity (WLHP)	EER (WLHP)	Heating Capacity (WLHP)	COP (WLHP)
LV007	2.0	6,100	12.20	7,800	5.30
LV009	2.5	8,200	12.40	9,900	4.70
LV012	3	10,900	12.20	13,000	4.30
LV015	4	14,200	12.80	16,100	4.30
LV018	5.0	19,400	13.40	22,200	4.60
LV024	6	23,400	13.40	26,600	4.40
LV030	7	29,200	13.20	33,400	4.30
LV036	9	37,900	14.15	41,800	4.30
LV041	9	39,500	13.10	44,600	4.30
LV042	10	40,000	13.70	43,000	4.30
LV048	12	45,900	13.00	56,400	4.30
LV070	16	64,000	13.30	72,800	4.40

Tabulated performance data is at noted water temperatures and entering air conditions of 80.6°F DB/66.2°F WB at AHRI/ANSI 13256-1 rated CFM with 1" disposable filter.

GLHP ratings require an extended range option. ECM motors can be either constant torque or constant CFM.

Model	Fluid Flow Rate	AHRI/ANSI 13256-1 Performance Data							
		Entering Water Temperatures							
		86 °F		68 °F		77 °F		32 °F	
		Water Loop				Ground Loop			
		Capacity and Efficiency Data – ECM Motor with TXV (Option)							
		Cooling Capacity (WLHP)	EER (WLHP)	Heating Capacity (WLHP)	COP (WLHP)	Cooling Capacity (GLHP)	EER (GLHP)	Heating Capacity (GLHP)	COP (GLHP)
LV015	4	13,700	13.90	15,500	4.40	14,400	16.20	10,700	3.30
LV018	5.0	19,700	14.40	21,900	4.80	21,500	15.90	14,100	3.70
LV024	6	23,800	14.50	26,200	4.60	25,400	16.80	16,700	3.60
LV030	7	30,000	15.00	32,800	4.60	31,600	17.50	20,400	3.40
LV036	9	38,200	14.65	41,400	4.70	40,200	17.70	26,500	3.60
LV041	9	40,500	13.60	43,700	4.40	42,200	15.90	28,500	3.60
LV042	10	40,900	14.10	45,300	4.40	43,500	16.30	30,100	3.50
LV048	12	46,800	14.20	55,600	4.50	49,600	16.30	34,600	3.60
LV060	15	59,000	14.30	66,400	4.30	61,100	16.40	46,200	3.30
LV070	16	65,200	14.60	71,800	4.60	67,600	16.60	50,000	3.50

Model	Fluid Flow Rate	AHRI/ANSI 13256-1 Performance Data			
		Entering Water Temperatures			
		86 °F		68 °F	
		Water Loop			
		Capacity and Efficiency Data – ECM Motor with capillary tube (Option)			
		Cooling Capacity (WLHP)	EER (WLHP)	Heating Capacity (WLHP)	COP (WLHP)
LV015	4	13,700	13.90	15,500	4.40
LV018	5.0	19,700	14.40	21,900	4.80
LV024	6	23,800	14.50	26,200	4.60
LV030	7	30,000	15.00	32,800	4.60
LV036	9	38,200	14.65	41,400	4.70
LV041	9	40,500	13.60	43,700	4.40
LV042	10	40,900	14.10	43,000	4.40
LV048	12	46,800	14.20	55,600	4.50
LV060	15	59,000	14.30	66,400	4.30
LV070	16	65,200	14.60	71,800	4.60

Tabulated performance data is at noted water temperatures and entering air conditions of 80.6°F DB/66.2°F WB at AHRI/ANSI 13256-1 rated CFM with 1" disposable filter.

GLHP ratings require an extended range option. ECM motors can be either constant torque or constant CFM.



FHP Equipment

Specializing in efficient green technology for commercial heating and cooling products. FHP products are one of the leading Geothermal and Water Source heat pumps in the market, which assures that you are buying a unit that you can trust. Bosch Thermotechnology Corp. is dedicated to providing highly efficient heating and cooling solutions to the private and public sectors.

Bosch Thermotechnology Corp. is always on the forefront of product development and innovative design to optimize the performance of FHP units. Our products are designed and manufactured to the highest quality, reflecting the no-compromise standards for which FHP and Bosch are renowned in order to provide our customers with the highest level of satisfaction and comfort. The variety of options, energy efficiency, and uncompromising quality of all FHP products makes them the ideal choice for the commercial new construction market and the ease of designing into tight retrofit spaces of buildings.

Advantages of FHP Technology

- ▶ Low installation costs
- ▶ Lower operating costs
- ▶ Flexibility and comfort
- ▶ Energy efficiency
- ▶ Space savings
- ▶ Superior quality
- ▶ Quiet operation



LV Model 007 - 070

- ▶ 13 Models from 1/2 through 6 tons
- ▶ Horizontal, Vertical, and Counterflow Configurations*

The LV Model is a cost-effective, single stage water source heat pump designed for commercial retrofit and new construction applications.

*Not all model sizes are available in all configurations. Consult the charts found in this catalog for details.

Features, Functions and Benefits

Cabinet

The LV unit cabinetry is constructed using heavy-gauge, galvanized steel. This steel provides superior corrosion protection for units located indoors.

All interior surfaces are lined with 1/2" thick, 1.5 lb./cu. ft. density, Micromat insulation for thermal insulation and acoustical attenuation. This insulation is non-combustible, non-hydroscopic and does not support fungal growth. Insulation meets NFPA 90A and 90B for fire protection and is certified to meet the GREENGUARD® Indoor Air Quality Standard for Low Emitting Products.

Protection against corrosion is a feature in the LV unit. A stainless steel drain pan will last the lifetime of the unit and resist corrosion and cracking that may occur with steel or plastic materials.



**MERV-8 or MERV-13
Filter Option**



**2" 4-Sided Filter
Rack Option**

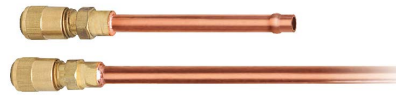

**Schrader
Charging Valves**

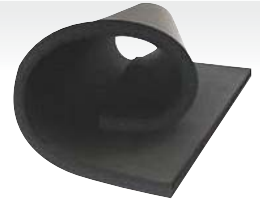

**Closed Cell Foam
Insulation (Optional)**

Quiet Operation

Noise reduction is a critical consideration of the unit design. All LV units have a distinct floating base pan; the compressor is mounted on a heavy steel plate which rests on a high density rubber pad on the base of the unit. In addition, compressors are mounted on rubber grommets. This double isolation, distinct to FHP equipment, is standard in all LV units preventing vibration and noise transmission from the compressor to the unit structure, resulting in exceptionally quiet operation.

The LV offers optional 1/2" thick, closed cell foam insulation to help aid indoor air quality (IAQ) and to further attenuate low frequency noise from the compressor compartment. The closed cell foam insulation option is available in all unit sizes. For additional sound attenuation, an optional compressor blanket is available on unit sizes 024 and above.

Serviceability

All units are designed to be serviced from the front of the unit. Schrader valves for high and low pressure gauges and the electrical box components are easily accessible for diagnosing and servicing the unit. Insulated bulkheads in all units, separate the compressor section from the blower section, allowing the unit to be serviced during operation.

Large removable panels aid in servicing the unit, when necessary. Separate electrical knockouts in the unit corner post allow for easy and safe routing of high and low voltage lines to the inside of the cabinet.

Unit Configurations

All units are available in horizontal, vertical and counterflow configurations. Additionally, several options of return air and supply air are offered as standard, providing configuration flexibility.

Filter Racks and Options

Units come standard with a 1" filter rack and construction filter. A 2" four-sided filter rack and pleated filter is optional and greatly improves air filtration. Filter doors allow for easy routine maintenance and changing of the air filter. A 1" return duct collar is integral to the filter rack eliminating the need for field mounted duct collars.

MERV-8 and MERV-13 Filters

The optional MERV-8 or -13 filter is most advantageous for premium air filtration on commercial HVAC projects. High efficiency filtration is a cost-effective way of upgrading air quality while maintaining low pressure drop and sustaining long service life. These filters effectively remove up to 98% of airborne matter, such as fine particulates, bacteria, smoke, gases and allergens including dust mites, pollen, mold spores, dust and smog. MERV-8 and MERV-13 rated filters are a minimum requirement for EQ credits 3.1 and 5 on LEED projects. With the standard ECM constant airflow motor the LV is prepared to handle higher external pressure drops when utilizing the higher efficiency MERV-13 filters.



Standard



Optional

Subject to change without prior notice.



**Constant Airflow
ECM Option**



**Constant Torque
ECM Option**



**2-Way Valve with
Actuator**



Coax Coil

Fan Motor

Permanent Split Capacitor Motors (PSC)

The standard motor for all LV model heat pumps (except size 060) is a PSC motor. For all models other than 575 V units, the supplied motor is a three speed motor. 575 V motors are single speed.

ECM Constant Torque Motor (Optional)

The LV's constant torque blower motor option offers improved efficiency (up to 33%) over the standard PSC motor. This motor is similar in function to a PSC, but can handle up to 1 in.w.g. external static pressure making it a wise choice for high filtration applications. These motors are available in unit sizes 015 to 070. This ECM motor option is an excellent choice for retrofit. The constant-torque motors do not require a neutral wire for 460/3 power.

ECM Constant Airflow Motor

The LV's new high efficiency ECM motor option, available in 1/3hp to 1hp, provides constant airflow in a wide static pressure range up to 1 in.w.g. Available in unit sizes 015 to 070, this motor is a great choice in high filtration applications, such as MERV-13. The motor has a soft start/stop feature, keeping noise to a minimum. LV units outfitted with any ECM motor can see an efficiency boost with up to 1.8 additional points of EER. Passive dehumidification can be achieved with the constant airflow ECM by reducing nominal airflow by 15%. This control feature lowers air coil temperature and prevents over-cooling of the space when in dehumidification mode. **IMPORTANT NOTE:** The constant airflow ECM requires a neutral wire in a 460V application.

Hanging Brackets

All horizontal units come standard with hanging bracket kits for suspending the unit from field supplied hanger rods. These kits include heavy-duty steel brackets and rubber grommets for sound and vibration isolation from the building structure.

Water Connections

All water connections are heavy-duty bronze FPT fittings securely fastened to the unit corner post. This allows connecting to a flexible hose kit without the use of a backup wrench making for easier, faster installation.

Two-Position Water Valve

The two-position motorized water valve is optional on all unit sizes and is a great energy savings option. The valve opens to allow 100% fluid flow through the coaxial heat exchanger only when there is a call for cooling or heating. Closing off fluid flow to the unit when there is no call for cooling or heating reduces system operating costs, when using variable speed pumping, by reducing the speed of the primary loop pumps.

Refrigerant Circuit

LV units are designed using the optimum combination of compressor, water and air coils to provide peak performance. LV units are rated to withstand 600 PSIG working refrigerant pressure and 400 PSIG working water pressure. Heavy-duty heat pump compressors are used in all units. Rotary, reciprocating and scroll compressors offer optimum performance for each unit size.

**Compressors****Tin Plated with Coated Fin
Evaporator Coil (Optional)****Blower Housing
(with Removable Inlet Ring)**

Refrigerant to water heat exchangers are coaxial tube-in-tube type providing a robust construction, ensuring years of trouble free operation. Coaxial coils are selected and designed for peak performance, offering the best combination of low water pressure drop and maximum heat transfer in both the cooling and heating modes. Standard coaxial coils have a copper interior water tube and a steel outer shell. Optional Cupro-Nickel coils are available for applications where the water is of lower quality.

In geothermal applications where fluid temperatures can drop below the dew point of the surrounding air, optional insulation is available to prevent water coils and refrigerant piping from sweating.

Air side refrigerant coils have copper tubes, aluminum fins and side plates to prevent corrosion.

Air coils are state of the art, employing lanced fin and rifled tubing for maximum heat transfer. Large face areas result in lower face velocity reducing sound while ensuring high latent heat removal for maximum dehumidification in the cooling mode.

A pilot operated four-way reversing valve in the refrigeration circuit allows the unit to operate in either the heating or cooling mode. All FHP units have the reversing valve energized in cooling mode. This will ensure you are not left without heat in the middle of winter, should the reversing valve coil fail.

Refrigerant flow to the air coil is metered by capillary tubes as standard in LV units. Thermal Expansion Valves come with the optional Extended Range LV and are designed to vary the flow of refrigerant depending on the load. TXV's provide unit optimization and a more stable control over a wider range of operating conditions.

Evaporator Coil and DuoGuard™ (Option)

Air handling sections come standard with a copper tube aluminum fin evaporator coil. Available as an option is the DuoGuard™ evaporator coil protection system. DuoGuard™ Protection® - Tin Electro-Plated Copper Tubing with High-Tech Polymer Coated Aluminum Fins will aid in protecting the evaporator coil from most forms of corrosive elements in the airstream. The tin plating provides a best-in-class protection of the copper tubing from formicary corrosion while the fin coating provides protection against salt spray and other corrosive elements. DuoGuard™ protected coils are able to exceed 1000 hours salt spray per ASTM standard B-117.

Blower Housing

A removable inlet ring is a standard feature of the blower housing on all unit sizes. The removable inlet ring helps facilitate motor removal without having to remove the fan housing from the cabinet.

Unit Protection Module

Each LV Model is factory provided with a Unit Protection Module (UPM) that controls the unit operation and monitors the safety controls that protect the unit. The UPM interfaces with the thermostat or direct digital controller. The main purpose of the UPM is to protect the compressors by monitoring the different states of switches and sensors. This module provides time delays and protects the unit against freezing of the water to refrigerant and air to refrigerant heat exchangers as well as condensate overflow.



TXV Valve (Optional)



UPM Control Board

Safety controls include the following as standard:

- ▶ High pressure switch located in the refrigerant discharge line.
- ▶ Low pressure switch located in the unit refrigerant suction line.
- ▶ Standard low fluid temperature (freeze) protection sensor. The freeze protection sensor, located on the refrigerant liquid line entering the coaxial heat exchanger, is designed to disable compressor operation when the unit is in the heating mode, should the refrigerant temperature fall below either 26°F (-6.6°C) or 15°F (-9.4°C).
- ▶ Condensate overflow protection sensor is standard and factory mounted in the drain pan of the unit.
- ▶ Low air coil temperature (freeze) protection sensor disables the compressor when the refrigerant entering the air coil drops below 30°F (-1.1°C).

UPM Control Board Features

- ▶ **Condensate Overflow Protection** – The UPM controller continuously monitors the drain pan for high condensate water level, and if this exceeds normal operating levels, the compressor operation is interrupted to protect against drain pan overflow.
- ▶ **Anti-Short Cycle Timer** – 5 minute delay on break timer to prevent compressor short cycling.
- ▶ **Random Start** – Each controller has a unique random start delay ranging from 270 to 300 seconds after power is applied to the board. This will prevent the simultaneous start of multiple units after a power outage.

- ▶ **Low Pressure Bypass Timer** – The low pressure switch is bypassed for 120 seconds after a call for compressor operation to prevent nuisance low pressure lockouts during cold start-up in the heating mode.
- ▶ **Brownout/Surge/Power Interruption Protection** – Prevents compressor operation should the voltage drop below 10% of unit rated value. The unit will restart once the voltage is within tolerance and the random start has timed out.
- ▶ **Malfunction (Alarm) Output** – The controller has a set of contacts for remote fault indication. This can be either a steady output or can be set to pulse with the fault code. Two connections are available - one to provide a 24 volt output, the other to provide a dry contact.
- ▶ **Test Service Mode** – A dip switch setting is provided to reduce all time delay settings to 10 seconds maximum during troubleshooting for verification of unit operation.
- ▶ **LED Fault Indication** – Two LED indicators are provided as follows:
 - ▶ **Green:** Power LED indicates 18 – 30 VAC present at the board.
 - ▶ **Red:** Fault indicator with blink codes identifying the particular fault. This information is available via the malfunction (alarm) output contacts.
 - 1 Blink** - High Pressure
 - 2 Blinks** - Low Pressure
 - 3 Blinks** - Low Fluid Temperature (Freeze Protection)
 - 4 Blinks** - Condensate Overflow
 - 5 Blinks** - Brownout condition

► **Intelligent Reset**—If a fault condition is initiated, the 5 minute delay on break time period is initiated and the unit will restart after this delay expires. The UPM is configurable for either 2 or 4 fault occurrences before going into a hard lockout. The selection is made through a dip switch setting on the board. If the fault condition still exists or reoccurs twice or four times within one hour, the unit will go into a hard lockout and requires a manual lockout reset. A condensate overflow fault will, however, put the unit into a hard lockout immediately.

► **Lockout Reset**—A hard lockout can be reset by turning the unit thermostat off and then back on or by shutting off unit power at the circuit breaker. The method of reset is selectable by the dip switch on the board.

Additional Options

- Blower monitor relay
- Compressor monitor relay
- Phase monitor
- Pump relay
- Fire alarm relay
- Fault LED light
- 50, 75 or 100 VA transformer option
- 40 Amp disconnect switch
- Single and three phase

Hot Gas Reheat

Hot gas reheat (HGR) allows the user to not only control space temperature, but also humidity levels within the conditioned space. Excessive moisture in the space can promote mold growth leading to damage in the structure or interior surfaces, as well as reducing the air quality and creating an unhealthy environment.

Possible causes of excess humidity could be a byproduct of the unit having to operate under a widely varying load, an oversized short cycling unit, a high percentage of unconditioned outside air being introduced into the space, a high latent load in the space or any location where humidity infiltration is a problem.

Typical unit control is by a wall mounted thermostat that senses temperature in the occupied space. By utilizing a humidistat in addition to the thermostat, LV units with Hot Gas Reheat are able to control the humidity levels in the space as well. The Hot Gas Reheat option allows cooling and dehumidification to satisfy both the thermostat and humidistat while preventing over-cooling of the space while in the dehumidification mode.

Once the thermostat reaches set point temperature, the humidity is above set point, the unit controller will energize the reheat valve operating the unit in hot gas reheat mode, first cooling and dehumidifying, then reheating the air (using hot refrigerant gas) before delivering it to the space, usually 2° to 5°F below room temperature. The unit operates like a dehumidifier by reheating the air along a constant sensible heat line, while the relative humidity of the leaving air is reduced. This option offers significant energy savings over reheating air with electric heating coils.

The moisture removal capacity of a specific heat pump is determined by the unit latent capacity rating. A heat pump's latent capacity can be determined by reviewing the heat pump specification data sheets. Depending upon the entering water and air conditions, a total and sensible capacity can be interpolated from the data sheets. Subtracting sensible capacity from total capacity yields latent capacity. Dividing the latent capacity by 1069 converts the amount of moisture removal from BTU/Hr. to Pounds Per/Hr.

A hot gas reheat valve and a reheat coil are included in the refrigerant circuit. The refrigerant circuit in the cooling and heating mode is identical to a standard heat pump.

In the reheat mode, the compressor discharge gas is diverted through the reheat valve to the reheat coil which is located downstream of the cooling coil. The superheated refrigerant gas reheats the air leaving the cooling coil. The hot refrigerant gas then passes through the water to refrigerant coil where it is condensed to a liquid. From this point the rest of the cooling cycle is completed as in a regular heat pump. There are check valves to prevent refrigerant flow into the reheat coil during standard cooling/heating cycles.

Hot Gas Reheat Control Options

There are several ways to control heat pumps with hot gas reheat. You should choose the means that best suits your specific application. Please refer to the Hot Gas Reheat wiring diagrams for typical thermostat wiring. Most heat pump compatible thermostats in conjunction with a humidistat are acceptable for use, (Note: “O” output for reversing valve energized in cooling mode is required.) Combination thermostat/humidistats are also available.

Special Considerations

Some applications require special attention to maximize the performance of the hot gas reheat function:

- ▶ Low Temperature Well Water
- ▶ Indoor Pool Dehumidifying During Winter Months (Re: Heating Mode)

Consult the factory for special application considerations.

Low Temperature Well Water

When low temperature well water is utilized as the water source (below 55°F), a means of establishing two flow rates, one for the cooling/reheat mode and one for heating mode is recommended. In the cooling mode at low entering water temperatures and standard flow rates, discharge pressures and corresponding discharge gas temperatures are relatively low. At these conditions, when the reheat mode is initiated, the low temperature discharge gas can reduce reheat capacity. A means to reduce the water flow rate and elevate the discharge pressure/temperature in cooling/reheat mode should be provided. Conversely, at low entering water temperatures in the heating mode, system suction pressure is reduced causing a loss in heating capacity. A means of providing higher flow in the heating mode should be supplied. The simplest way to accomplish the above is to install water regulating valves.

Indoor Pool Dehumidifying During Winter Months

It is important to remember that when in the reheat/dehumidification mode the heat pump is cooling and reheating. A secondary means of heating the space during the dehumidification mode should be provided. For indoor pool environments, the indoor space temperature should be kept at least two (2) degrees F

the pool water temperature. If this is not done the warm pool water attempts to heat the space and the humidity levels increase exponentially. The heat pump is normally sized to handle the design latent load moisture removal. A second heat pump or resistance heat should be provided to handle the structure’s shell loss load. DuoGuard™ evaporator coil option is required for this application.



Protective coatings are highly recommended for all pool applications, due to the highly corrosive chemical environment.

Sequence of Operation - Modulating Hot Gas Reheat (MHGRH)

Modulating Hot Gas Reheat differs from On/Off in that the reheat function is always active. The purpose of Modulating Hot Gas Reheat is to deliver supply air at or close to neutral conditions.

Air is cooled and dehumidified by the cooling coil to around 55°F DB/54°F WB. A sensor located in the supply air stream is set at the required leaving dry bulb temperature and will send a signal to the modulating hot gas reheat valve to direct the flow of hot gas to maintain that temperature. A typical application for this would be in treating 100% outside air. This air would be ducted directly into the space relieving the unit handling the zone of any outside air load. This can result in a smaller zone unit, less airflow and a savings in both initial and operating cost.

Control of the hot gas modulation is by the thermostat in the supply air duct or through a building management system. A separate controller is used to control the unit itself.

Hot Gas Bypass

The function of the hot gas bypass valve is to prevent icing of the air coil when the unit is operating at low cooling load conditions. This situation could arise if the space experiences widely different loads, for example a conference center or if a unit is sized for heating, it could be oversized for cooling. Without a hot gas bypass circuit the evaporating temperature could fall and ice could form on the coil restricting airflow and aggravating the situation. Eventually the heat pump could lock out on air coil freeze protection.

The hot gas bypass valve located in the compressor discharge line diverts hot gas to the inlet of the air coil. The valve is factory set to open when the evaporating pressure falls to 90 PSI and will modulate to prevent the pressure falling any lower. This setting is field adjustable and this set point may be adjusted as required.

Psychrometric Chart

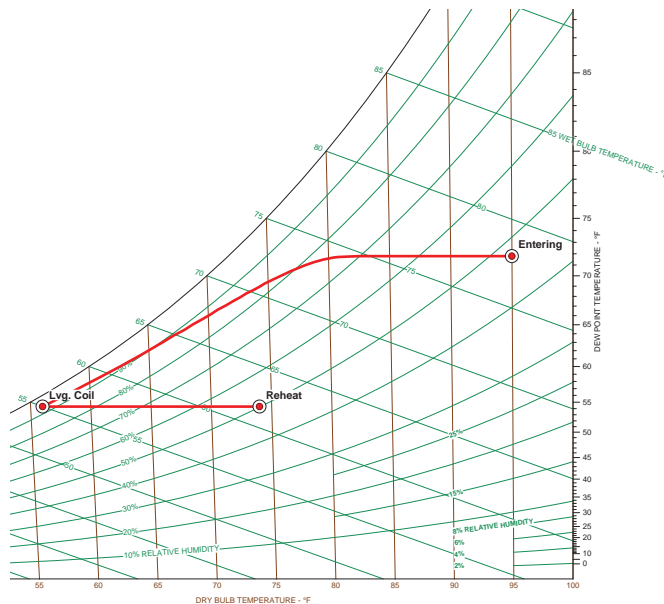

Figure 1

DDC Controls

The optional factory mounted DDC Controller is preprogrammed and installed on the unit with the Unit Protection Module (UPM) to be job site ready. The unit will operate in a 100% stand-alone control mode or connect to a Building Automation System (BAS) using open protocols BACnet™, Modbus, N2 or LonWorks® (with an optional Lon card). Stand-alone DDC modules must use remote intelligent sensors and are to be programmed by the BACview® controller only.

Zone temperatures, leaving air temperatures and water temperatures can be monitored from the central control computer and unit fault indication displayed. Available inputs/outputs include:

- ▶ Discharge air temperature
- ▶ Leaving water temperature
- ▶ Fan run time
- ▶ Override time remaining

- ▶ Night setback status
- ▶ Percent of units cooling
- ▶ Percent of units heating
- ▶ Cooling set point
- ▶ Heating set point
- ▶ Status of all the alarms
- ▶ Space temperature
- ▶ Occupied heating and cooling set points
- ▶ Continuous or cycle fan during occupied mode
- ▶ Command for occupied or unoccupied mode
- ▶ Command for override of the unoccupied mode (unit resorts to occupied set points)
- ▶ Set point adjustment

DDC Room Sensors

To complement the controller, Bosch offers a line of intelligent space sensors, which provide precision measurement and communication capabilities in an attractive low profile enclosure. A hidden communications jack provides access to the HVAC control system for commissioning and maintenance.

Models available include:

- ▶ **The RS Pro** has a large LCD display and easy-to-use occupant controls for set point adjustment.
- ▶ **The RS Plus** offers a local set point adjustment and override to an occupied mode and LED indication of current status.
- ▶ **The RS Standard** which has no local temperature set point adjustment.

A BACview® hand held diagnostic tool is available to allow local access to display and modify user defined properties without any computer software. These space sensors will monitor, sense and provide local control for the room.



BACview® Hand Held Diagnostic Tool

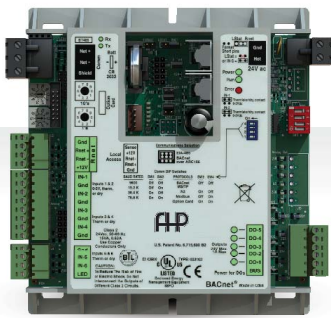

DDC Control Board



RS Base
DDC Sensor



RS Plus
DDC Sensor



RS Pro
DDC Sensor

DDC Zone Sensors*

The Pro Zone Sensor (ZS) has an LCD screen that can display the current temperature and set temperature. It can also display relative humidity and CO₂ settings as well as their current readings. It comes with a button for additional information that can be displayed.

The Pro ZS can be ordered in any of the following combinations:

- ▶ Temperature setting only
- ▶ Temperature with relative humidity settings
- ▶ Temperature, relative humidity, and CO₂ settings

The Plus Zone Sensor (ZS) has a little different look to it. It has a occupied indicator that identifies the sensor to be operating in occupied conditions. It comes with a slide bar of for some manual temperature control in the occupied mode +/- setting can be adjusted during commissioning.

The Plus ZS can be ordered in any of the following combinations:

- ▶ Temperature setting only

The Base Zone Sensor (ZS) is limited to only sensing capabilities without local controllability. This zone sensor offers a basic look and blends into most decors.

The Base ZS can be ordered in any of the following combinations:

- ▶ Temperature sensor
- ▶ Temperature and relative humidity sensor

* DDC Zone Sensors available through Applications Special Handling Sheet. When the Zone Sensors (ZS) are available as a standard option they will replace the Room Sensors (RS).

Waterside Economizer

Common Waterside Economizer Applications

- ▶ Commercial application where perimeter heating is taking place while core cooling is required. Perimeter heat pumps operating in the heating mode extract heat from the building loop, thus dropping the building loop fluid temperature. Internal core cooling requirements are usually high even in the winter months due to people, lighting, and equipment loads. The moderate temperature loop water circulated through a core heat pump's waterside economizer coil can provide free-cooling without the use of mechanical cooling (Compressors). Also, in many areas code requires some type of economizer cycle. Waterside Economizers in lieu of air side economizers are an inexpensive way to satisfy code requirements in commercial applications.
- ▶ Can also be sized up for preheating.
- ▶ Tenant build out commercial applications where the central chilled water fluid loop serves as a individual zoned heat pump condenser water. In this application low temperature fluid is always available for free-cooling.

Fluid Flow

Fluid flow through heat pumps equipped with waterside economizer coils is directed by the use of a single three-way motorized ball valve. Flow is either through the waterside economizer coil and then through the condenser or through the condenser only. When applying these units to a variable speed pumping system, a separate field provided means of positive flow shut-off is required. (Re: A positive shut-off solenoid valve located down stream of the heat pump. See figure 2 on next page).



Waterside Economizer (Optional)



Fluid Differential Pressure Switch (Optional)

Aquastat

The aquastat controller is mounted to the heat pump electrical control box. All electrical control wiring is factory installed. The controller is supplied with an external range adjustment and screwdriver slot. Actual range is -30° to 100°F and requires field setting. The remote bulb stored inside the heat pump for shipping requires field mounting.

Recommended settings: 45° F Cool, 90° F Heat

Air Side Pressure Drop

The air side pressure drop shown on the waterside economizer performance tables is considered as additional heat pump external static pressure. Refer to Bosch Select Tools selection software for blower performance and to determine if the unit requires an optional fan upgrade.*

*See fhp-mfg.com for BST Software.

Fluid Differential Pressure Switch

The function of the differential pressure switch is to prevent or stop compressor operation should the water supply fail. This will prevent the unit from locking out on a safety requiring a manual reset to restart. This optional control is internally mounted and factory installed.

The switch is piped between the water entering and leaving connections. Should the pressure drop across the water to refrigerant heat exchanger and fall below set value, the switch will open de-energizing the compressor. The blower operation will not be affected by this option.

Energy Management Switch (EMS)

This switch allows you to connect to an energy management system that can turn the unit off and on.

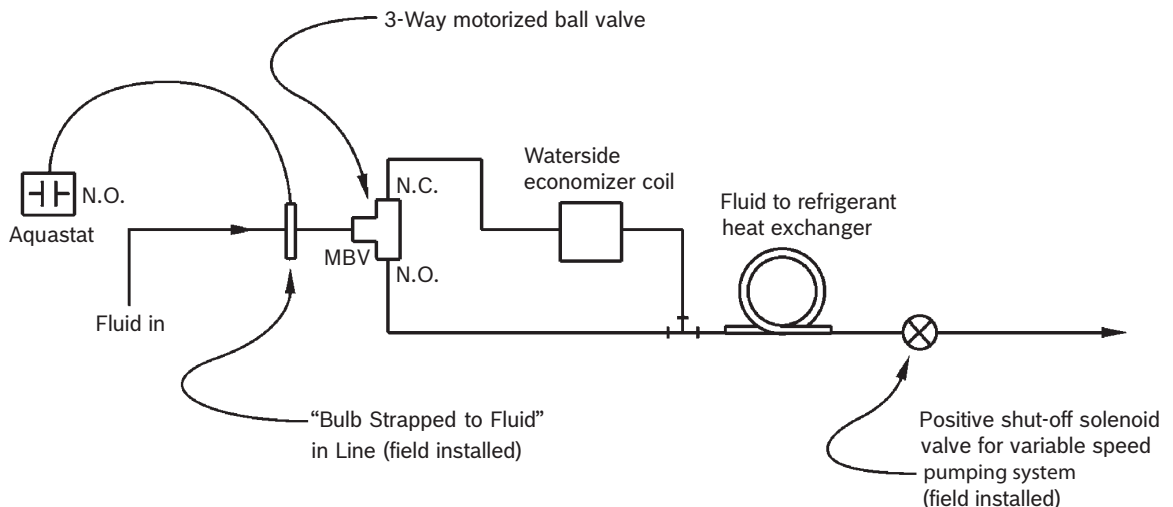

Figure 2



Thermostats



Hose Kit

Accessories

Thermostats

The unit control may be as simple as a single stage thermostat or the unit may have a DDC controller integrated into the building management system.

All external low voltage control wiring is made to the thermostat terminal located in the unit electrical box.

Thermostats may be manual change over, auto change over, programmable or non-programmable depending on the requirements of the project. A full line of thermostats are available as an accessory.

Hose Kits

Hose kits are recommended between the unit and system loop piping. This will help eliminate the transmission of vibration and noise from the unit to the space.

Hoses are fire rated fiber reinforced EPDM Stainless Steel braid hoses with swivel connections.

Maximum working pressure 400 PSI for sizes 1/2" – 1" diameter and 300 PSI for sizes 1 1/4" – 2".

A variety of hose kits are available depending on the job requirement.

- ▶ **Kit 1:** Hoses only. 3/4" through 2" diameter hoses are available with 24" and 36" hose lengths. 1/2" diameter hose kits are available only with 12" long hoses.
- ▶ **Kit 2:** Hose kit 1 with ball valves on the supply and return hoses. Valves have P/T (pressure/temperature) ports to facilitate pressure and temperature readings.
- ▶ **Kit 3:** Hose kit 2 with an automatic flow control valve. The design flow rate is preset at the factory per the design conditions and will automatically limit the flow to this value. This will greatly facilitate balancing of the fluid loop and ensuring each unit gets the required flow.
- ▶ **Kit 4:** Hose kit 3 with a Y-strainer and blow down valve on the supply side. The filter screen is 20 mesh, 304 stainless steel to help prevent dirt and debris from entering the water coil.
- ▶ **Kit 5:** Hose kit 3 with a 24 v 2 position solenoid valve. This could be used to shut off flow to the unit when there is not a call for heating or cooling. A typical application would be with VFD pumping.
- ▶ **Kit 6:** Hose kit 4 with a 24 v 2 position solenoid valve. Hose kit options are available in the accessories section of the BST selection software.

Unit Configuration Diagrams

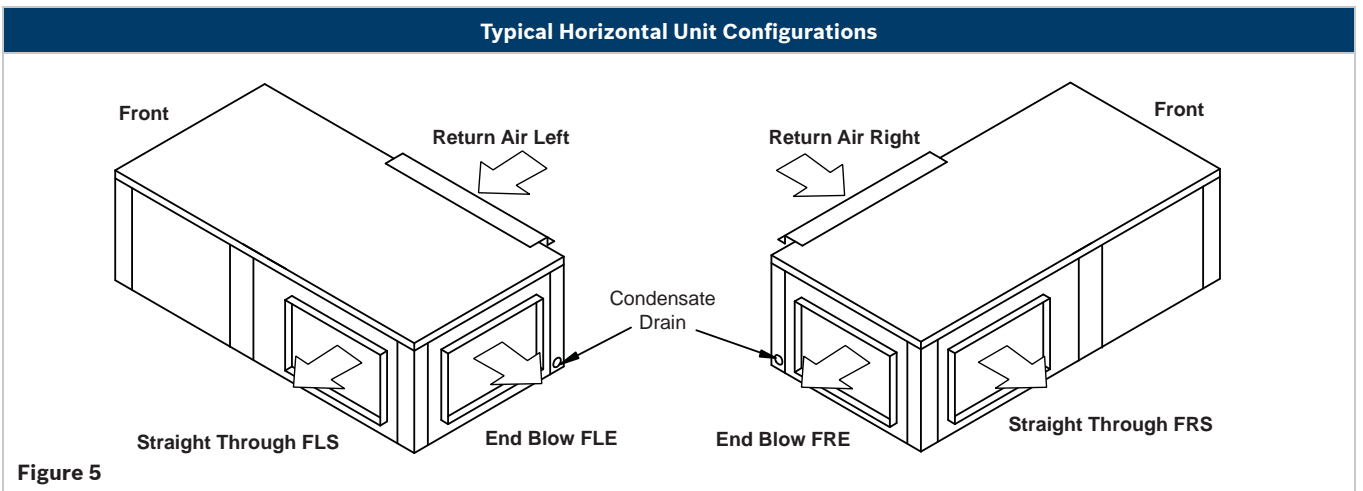
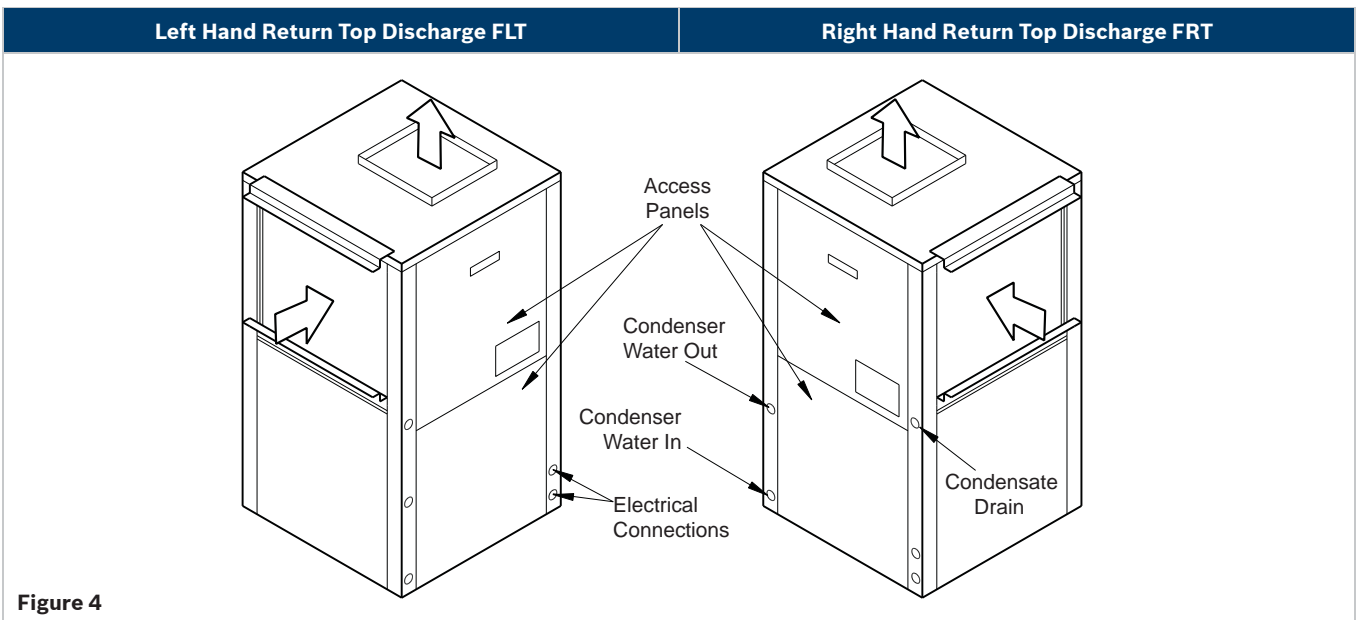
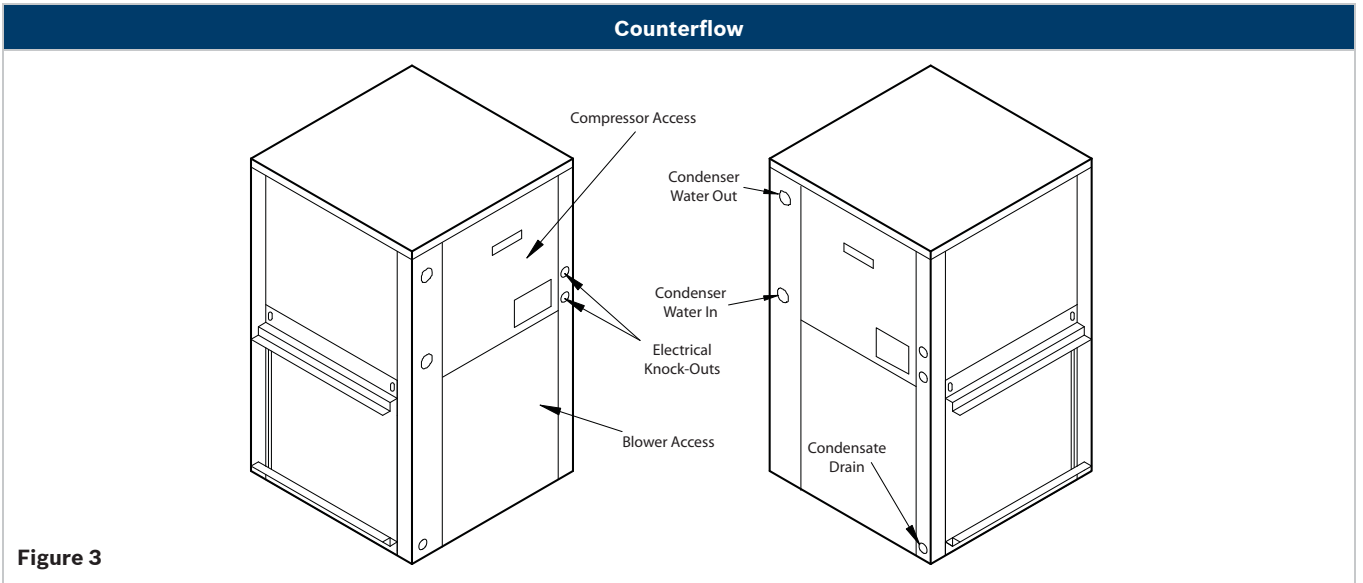

Systems

LV Models may be used in a variety of different applications depending on the system design. An overview of tower/boiler and geothermal systems is given below. There could be several variations and combinations of these systems.

Cooling Tower/Boiler Systems



Water source heat pumps with cooling tower/boiler systems have been used for many years and are recognized as having a low installation cost and providing more energy efficient operation than most other systems on the market.

In a typical building, each office or space would receive its own heat pump. This ensures that the unit will independently satisfy the heating or cooling requirements for that space irrespective of the requirements of any other space. Unlike some other systems, this offers individual control and enhanced comfort in all areas.

All the units are connected to a common water loop containing, in addition to the heat pumps, a cooling tower, boiler, a primary and standby pump and a loop water temperature controller. In the summer cooling mode, the units are cooling and rejecting heat to the water loop. This heat is then rejected to the atmosphere through a cooling tower. In winter, heat is taken from the loop and, together with the compressor's heat of compression, used to heat the space. The heat removed from the loop is then replenished by the boiler. The loop water temperature controller

will keep the fluid within certain temperature limits typically 70°F in winter and 85°F in summer by cycling either the cooling tower or boiler.

In today's modern buildings the interior core usually has a net cooling requirement year round irrespective of the outside temperature. This is due to the internal heat gains from people, office equipment and lighting. The heat from heat pumps operating in cooling is rejected to the common water loop and is absorbed by heat pumps on the building's perimeter that are in the heating mode. In effect the system is transferring energy around the building areas from where it is in excess to those areas where it is needed. In many instances we find a balanced system where the heat generated in the interior space is sufficient to heat the perimeter, resulting in neither the cooling tower nor boiler operating. This concept, unique to a water source system, provides the most energy efficient system on the market.

Geothermal Systems

The earth has a tremendous capacity of storing thermal energy, which can be utilized to heat or cool a building.

A geothermal system offers all the benefits of a cooling tower and boiler system with the additional advantage of having overall greater energy efficiency. As the cost of energy increases, geothermal installations are becoming the system of choice by developers and design engineers.

There are several alternative methods of utilizing the energy contained in a geothermal system, giving the design engineer several options for selecting the one that is right for a particular application.

Earth Coupling Options

Ground Loop Systems (Closed Loop)

Lengths of high density polyethylene piping are buried in the earth either in vertical bore holes or horizontal trenches depending on the space available.

Fluid from the loop inside the building circulates through these pipes either rejecting heat to the ground when there is a net cooling requirement or absorbing heat from the ground when heating is the dominant requirement.

The temperature of the earth below 6 feet is relatively constant and is not affected by the ambient temperature. For this reason, the ground temperature is cooler than the summer ambient and warmer than the winter ambient in most regions. Geothermal systems are able to operate effectively in extreme ambient conditions exceeding 100°F in summer and -30°F in winter. This is one of the reasons why geothermal systems have such an advantage over other systems. An additional advantage is that no fossil fuels are used, reducing the carbon emission of the building.

Even in areas which are cooling or heating dominant a hybrid system can be used with a downsized cooling tower or boiler. This system will reduce the installed cost significantly with only a modest impact on overall operating efficiency.

Geothermal systems may cost more to install but the savings in energy and low maintenance costs more than off set this with payback times typically five years or even less.

Vertical Ground Loop System



This method is used mainly in commercial buildings or where space for a loop field is limited. Vertical holes 100 to 400 feet deep are drilled in the ground, and a single loop of high density polyethylene pipe with a U-tube at the bottom is installed. The bore hole is then sealed with grout to ensure good contact for heat transfer with the soil. The size of the project will determine how many bore holes are required. The vertical ground loops are then connected to a horizontal header pipe that carries fluid to the building and circulated to each heat pump. The Earth's temperature is stable below the surface which is an advantage for this system and provides for the greater efficiency. Vertical ground loop fields may be located under buildings or parking lots. The life expectancy is in excess of 50 years.

Horizontal Ground Loop System



This type is cost effective on smaller projects or where there is sufficient space for the loop field. Trenches, three to six feet deep are dug in which a series of high density polyethylene pipes are laid. These loops are manifolded and connected to the loop inside the building which feeds the heat pumps. The fluid is then circulated, absorbing or rejecting heat to the earth depending on the requirement for heating or cooling.

Typical Heat Pump System

Surface Water, Lake or Pond System



This type of design is economical when a project is located near a body of water. Fluid circulates through polyethylene piping in a closed system, just as it does through ground loops, but in this case, underwater. The pipes may be coiled in a slinky to fit more surface into a given amount of space. The lake needs to be a minimum size and depth depending on the building load. Lake loops have no adverse impact on the aquatic system. Specialized lake heat exchangers are also available for this application. New technology is emerging for stainless steel and titanium heat exchangers.

Well Water System



This type of installation is only possible if there is sufficient ground water available in a well. The water must be of good quality. Local codes may limit the use of this system in certain areas. The arrangement is referred to as an open system which means that water

Subject to change without prior notice.

is pumped directly from the source into the geothermal unit and then discharged either into a return well or a body of water. The water quality is unaffected other than a change in the temperature. Refer to the installation manuals for water quality guidelines.

Typical Heat Pump Operation

Cooling Mode

In the cooling mode, hot high pressure refrigerant gas is pumped from the compressor to the water-to-refrigerant heat exchanger via the reversing valve. Water, or an anti-freeze solution, flowing through the water-to-refrigerant heat exchanger transfers heat from the refrigerant to the fluid raising the fluid temperature while condensing the hot gas into a liquid. This liquid refrigerant then flows through a metering device, where the refrigerant is expanded to a cold liquid, to the air-to-refrigerant heat exchanger coil.

The air-to-refrigerant heat exchanger cools and dehumidifies air by evaporating the liquid refrigerant. The cooling cycle is completed when the refrigerant flows as a low pressure gas through the reversing valve and back to the suction side of the compressor. Cool dehumidified air is circulated to the space maintaining comfort conditions.

Heating Mode

During the heating mode, the high pressure refrigerant gas is pumped from the compressor to the air-to-refrigerant heat exchanger coil via the reversing valve. In the air-to-refrigerant heat exchanger coil, the heat is removed by the air that passes over the coil surface, and the hot gas condenses into a liquid.

The heated air is ducted to the space and provides heating for the building. The refrigerant liquid then flows through a metering device to the water-to-refrigerant heat exchanger. Water, or an anti-freeze solution, circulates through this heat exchanger and is cooled by the evaporating refrigerant which evaporates into a gas. The heating cycle is completed when the refrigerant flows as a low pressure gas through the reversing valve and back to the suction side of the compressor.

Typical Unit Installation

Water-to-Air Heat Pump Cycle – Cooling

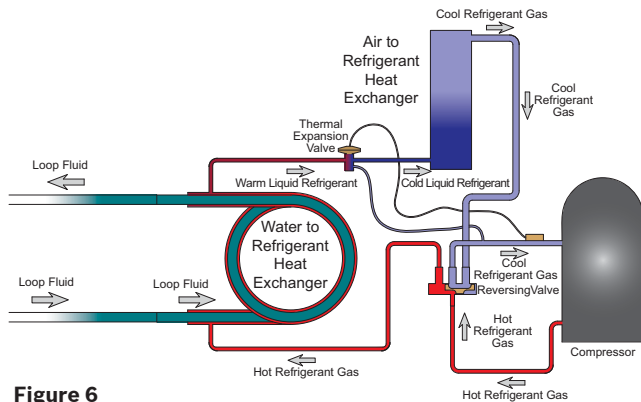

Figure 6

Water-to-Air Heat Pump Cycle – Heating

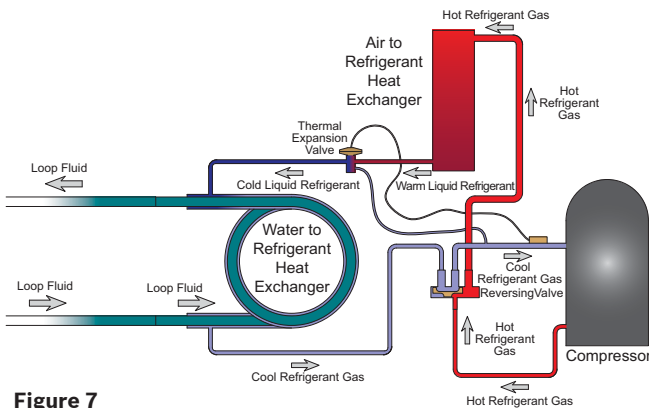

Figure 7

Unit Location

Any mechanical device will, at some point in time require servicing and repair.

With this in mind sufficient space must be provided around the unit for service personnel to perform maintenance or repair.

Units are not designed for outdoor installation. Avoid locations where the unit may be exposed to freezing conditions or where the humidity levels could cause condensation on the unit panels, for example, when exposed to outdoor ambient conditions.

Vertical Unit Installation

Vertical units are normally installed in a closet or mechanical plant room.

If installed in a closet or other confined space, ensure adequate space for return air to the unit.

Sufficient space must be provided for filter replacement and access to the compressor and blower for service.

Units should be set on a piece of rubber, neoprene or other vibration absorbing material at least 1/3" to 1/2" thick. The pad should extend 3/4" over the entire base of the unit.

Avoid direct line of sight to the unit. Install a sound baffle over any door that has a return air grille.

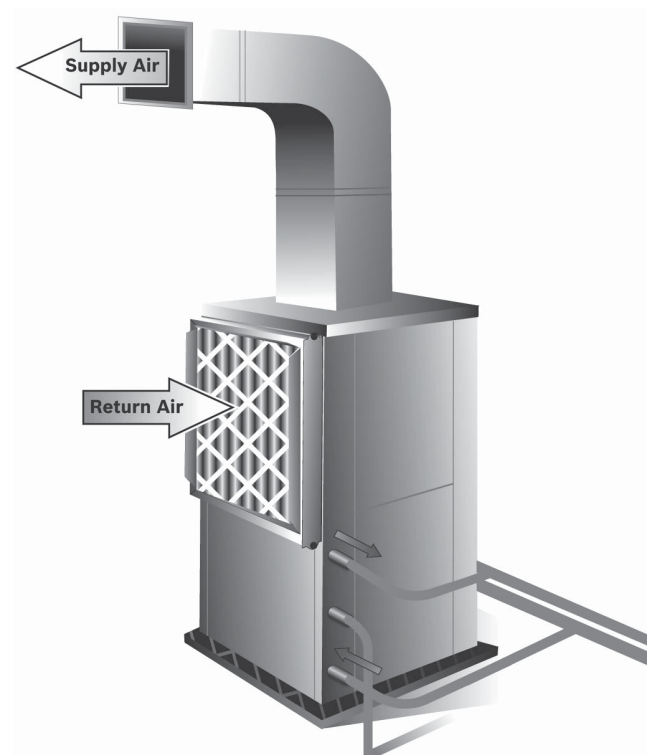

Figure 8

Typical Unit Installation

Horizontal Unit Installation

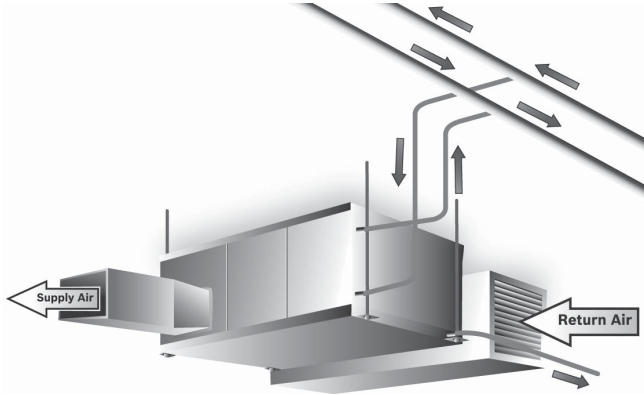

Figure 9

Horizontal units are typically suspended above the ceiling by four (field supplied) 3/8" threaded rods fastened to the unit by the factory supplied hanger bracket kits. The kits include rubber isolators to help prevent transmission of vibration and noise to the building structure. Units should be located directly below a structural member, so that it is securely anchored.

A horizontal unit should be positioned to allow for removal of the filters and access panels. Allow at least 18" clearance on each side of the unit for service and 36" in front of the unit for maintenance access. The filter needs to be slid out and sufficient space must be provided to allow this.

Do not install the unit above any piping or electrical raceways. The unit should be able to be removed to the floor without major rearrangement of other mechanical or ceiling components.

Consideration needs to be made as to the location of the units. Avoid installing units directly above occupied spaces (e.g. above office desks or classrooms). This will minimize possible disruption to the occupants if maintenance or service is required as well as keeping a potential source of noise out of the area. If possible, units should be installed above the hallway drop ceiling in schools, and the supply and return air is routed directly into classrooms. Local code may require fire dampers to be used in this application.

Ductwork and Sound Attenuation Considerations

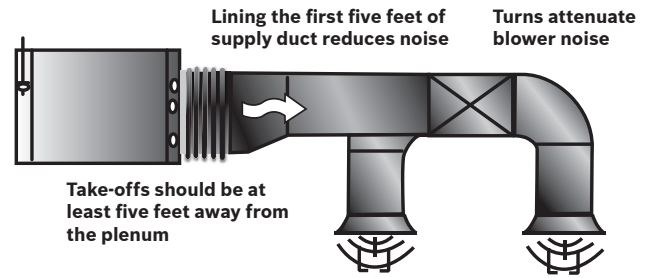

Figure 10: Supply Air Ducting

Sound is becoming an increasingly important factor in all HVAC installations. The LV models has been designed to minimize sound, but sound acoustical design plays an important part of the sound level in the space.

Most of the problems associated with HVAC generated sound can be avoided by paying close attention to duct design and equipment placement.

A discharge flange is provided on all horizontal unit models for fastening of ductwork. We recommend using a flexible collar between the discharge flange and the duct transformation to reduce vibration transmission from the cabinet and to simplify disconnection of the unit from the ceiling ductwork.

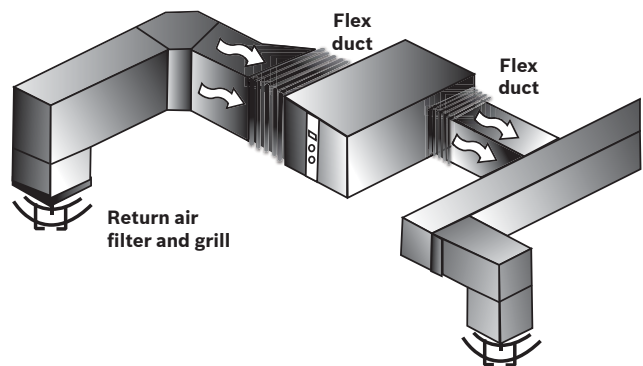

Figure 11: Return Air Ducting

Return air to the unit could be either free return or ducted. The filter rack is provided with a 1" flange should a ducted return be used. We recommend using a flexible collar between the return flange and the duct transformation to reduce vibration transmission from the cabinet and to simplify disconnection of the unit from the ductwork.

Sound is transmitted down the ductwork and it is important to avoid direct line of sight between the unit and the space, both on the return or supply side. To accomplish this, design the duct runs with two 90° turns.

As a general recommendation, duct interiors should have an acoustic / thermal lining of least 1/2" thick over the entire duct run or a minimum of the first 5 feet of the supply trunk.

Line the last five diameters of duct before each outlet with a 1" thick sound blanket. Line elbows and transition pieces, as well as a short distance upstream and downstream of the fittings.

Elbows, tees and dampers can create turbulence or distortion in the airflow. Using aerodynamic fittings will help in reducing this effect. Place a straight length of duct, 5 to 10 times the duct width, before the next fitting to smooth out airflow.

Diffusers that are located in the bottom of a trunk duct can also produce noise. Balancing dampers should be located several duct widths upstream from an air outlet. Ductwork should be mounted and supported using isolation devices that absorb vibration.

Applications such as Hotel, Motel, Dormitory or Nursing Home that use a single duct discharge are susceptible to noise. These applications typically have low static pressures and short duct lengths. In these applications the discharge duct must be fully lined and have a square elbow without turning vanes. A velocity not exceeding 500 to 600 fpm is recommended. Return air for these applications should enter through a sidewall grille and route up the stud space to a ceiling plenum.

For horizontal heat pumps mounted in the ceiling plenum, an insulated return plenum is sometimes placed at the return air opening to further attenuate line-of-sight sound transmission through return openings.

Piping

The water loop system is typically designed using a "reverse return" piping system which includes a flow control device so that flow requirements are met for each zone.

A high pressure stainless steel flexible hose kit is recommended to connect the unit to the building's hard piping and acts as a sound attenuator for both the unit operating noise and hydraulic pumping noise. One end of the hose has a swivel fitting to facilitate removal of the unit for replacement or service.

Hose kits come in several configurations, but in all cases should include supply and return shutoff ball valves to allow removal of a unit without the need to shut down the entire heat pump system. The hose kit may contain either a manual or automatic flow control that may be preset to ensure correct water flow to the unit.

Pressure / Temperature ports should be included in these fittings to allow the service technician to measure water flow and temperatures when checking unit operation.

Condensate Drain Piping

Condensate piping can be made of steel, copper or PVC pipe. In most cases, PVC pipe eliminates the need to wrap insulation around the pipe to prevent sweating.

A 3/4" FPT condensate drain connection is installed in the unit. The condensate piping must be trapped at the unit and pitched away from the unit not less than 1/4" per foot. A vent is required after the trap so that the condensate will drain away from the unit. The vent can also act as a cleanout if the trap becomes clogged. The condensate drain should not be directly piped to a drain/waste/vent stack. See local codes for the correct application of condensate piping to drains.

Operating Limits

LV Models are capable of operating over a wide range of conditions. For operation in a geothermal application or any other installation where the loop fluid temperature may drop below the ambient dew point, the extended range option is recommended. This consists of TXV in lieu of capillary tubes and additional insulation on the piping and wax exchanger to prevent condensation.

- ▶ Maximum and minimum fluid conditions are at unit rated flow rate.
- ▶ Maximum and minimum operating limits may not be combined. If one value is at either maximum or minimum, the other two should be at normal operating range.
- ▶ Entering fluid temperatures below 45°F in the heating mode requires antifreeze.

Equipment Selection

To ensure that you get the optimal performance from your FHP heat pump it is important that they be selected accurately to match your design conditions.

Prior to making equipment selections the zone conditions need to be determined. Bosch Thermotechnology Corp. recommends using a building load program to determine the heating and cooling loads.

The catalog provides a wide range of entering air and water conditions that will meet most applications. The unit performance can be determined by referring to the data tables from page 23 to 35.

Our Bosch Select Tools Selection Software (BST) is designed to provide you with a fast and accurate selection based on your specific conditions. This software is available through the commercial website. You may click on the BST link and request an account.

Unit Operating Limits—LV Model

Operating Limits – Cooling & Heating	Standard Unit	Extended Range Option
Cooling		
Minimum ambient air temperature °F	50	50
Maximum ambient air temperature °F	100	100
Minimum evaporator entering air db/wb °F	68/57	68/57
Rated air coil entering air db/wb °F	80/67	80/67
Maximum evaporator entering air db/wb °F	95/85	95/85
Minimum water coil entering fluid temperature °F	50	50
Water loop typical coil entering fluid range temperature °F	70/90	70/90
Maximum water coil entering fluid temperature °F	110	110
Heating		
Minimum ambient air temperature °F	50	40
Maximum ambient air temperature °F	100	85
Minimum evaporator entering air db °F	50	50
Rated air coil entering air °F	68	68
Maximum evaporator entering air db °F	80	80
Normal water coil entering fluid range °F	50-80	25-80*
Minimum water coil entering Fluid °F	50	20*

* Antifreeze solution is required at these fluid temperatures.

Antifreeze Correction Data

Antifreeze Correction							
Antifreeze Type	Antifreeze %	Cooling			Heating		WPD Correction Factor EWT 30 °F
		EWT 90 °F			EWT 30 °F		
		Total Cap.	Sens. Cap	Power	Htg. Cap	Power	
Water	0	1.000	1.000	1.000	1.000	1.000	1.000
Propylene Glycol	5	0.997	0.997	1.004	0.989	0.997	1.060
	10	0.994	0.994	1.006	0.986	0.995	1.125
	15	0.990	0.990	1.009	0.978	0.988	1.190
	25	0.983	0.983	1.016	0.960	0.979	1.300
Methanol	5	0.997	0.997	1.003	0.990	0.997	1.060
	10	0.996	0.996	1.005	0.979	0.993	1.100
	15	0.994	0.994	1.008	0.970	0.990	1.140
Ethanol	5	0.998	0.998	1.002	0.981	0.994	1.160
	10	0.996	0.996	1.004	0.960	0.988	1.230
	15	0.992	0.992	1.006	0.944	0.983	1.280
	25	0.986	0.986	1.009	0.917	0.974	1.400
Ethylene Glycol	5	0.997	0.997	1.003	0.993	0.998	1.060
	10	0.995	0.995	1.004	0.986	0.996	1.120
	15	0.992	0.992	1.005	0.980	0.993	1.190
	25	0.988	0.988	1.009	0.970	0.990	1.330
	30	0.985	0.985	1.012	0.965	0.987	1.400

Waterside Pressure Drop

Mixture of 15% methanol / water solution.

Model	Wtr. Flow Rate (GPM)	Wtr. PD w/o Int. Valve (psi)	Wtr. PD w/ Int. Valve (psi)
LV007	1.0	0.3	0.5
	2.0	1.1	1.8
	3.0	2.3	3.8
LV009	1.0	0.5	0.6
	2.0	1.7	2.3
	3.0	3.5	5.0
LV012	1.5	1.0	1.4
	2.5	2.6	3.6
LV015	2.0	1.9	2.5
	3.0	3.9	5.3
	4.0	6.5	9.1
LV018	2.5	1.1	2.1
	4.0	2.7	5.2
	5.0	4.0	8.0
LV024	3.0	1.7	2.0
	4.0	2.8	3.4
	6.0	5.8	7.2
LV030	4.0	2.0	2.6
	6.0	4.2	5.6
	8.0	7.0	9.6

Model	Wtr. Flow Rate (GPM)	Wtr. PD w/o Int. Valve (psi)	Wtr. PD w/ Int. Valve (psi)
LV036	4.5	1.6	2.4
	6.0	2.6	4.0
	9.0	5.4	8.6
LV041	5.0	2.0	3.0
	8.0	4.6	7.2
	11.0	8.2	13.1
LV042	5.0	2.0	3.0
	8.0	4.6	7.2
LV048	5.0	2.0	3.0
	8.0	4.6	7.2
	11.0	8.2	13.0
LV060	6.0	0.8	1.4
	8.0	1.4	2.5
	12.0	2.8	5.4
LV070	7.5	1.4	2.4
	10.0	2.3	4.1
	15.0	4.8	8.8

Based on 70° F

Subject to change without prior notice.

Capacity Data

LV007 (300 CFM)

Cooling									Heating					
Entering Fluid Temp (°F)	Water Flow (GPM)	Pressure Drop PSI (FOH)	Entering Air Temp (db/wb) °F	Total Capacity (MBTUH)	Sensible Capacity (MBTUH)	Heat of Rejection (MBTUH)	Power Input (kW)	EER	Entering Fluid Temp (°F)	Entering Air Temp (°F)	Total Capacity (MBTUH)	Heat of Absorption (MBTUH)	Power Input (kW)	COP
50	1	0.3 (0.6)	75/63	7.0	6.3	8.3	0.42	16.9	30	60	4.5	3.2	0.42	3.1
			80/67	7.5	6.5	8.8	0.42	18.1		70	4.4	3.0	0.45	2.8
			85/71	7.9	6.7	9.2	0.42	19.0		80	4.3	2.8	0.48	2.6
	2	1.2 (2.77)	75/63	7.5	6.5	8.6	0.37	20.3		60	4.9	3.6	0.43	3.3
			80/67	8.0	6.7	9.1	0.37	21.9		70	4.8	3.4	0.46	3.0
			85/71	8.5	6.9	9.7	0.36	23.5		80	4.6	3.1	0.49	2.7
	3	2.5 (5.77)	75/63	7.6	6.5	8.8	0.35	21.6		60	5.1	3.8	0.43	3.4
			80/67	8.1	6.8	9.3	0.35	23.4		70	5.0	3.5	0.46	3.2
			85/71	8.7	7.0	9.8	0.34	25.5		80	4.8	3.2	0.49	2.8
60	1	0.3 (0.6)	75/63	6.6	6.1	8.0	0.45	14.6	40	60	5.3	3.9	0.43	3.6
			80/67	7.1	6.3	8.5	0.46	15.7		70	5.1	3.7	0.46	3.2
			85/71	7.5	6.6	8.9	0.46	16.5		80	5.0	3.4	0.50	2.9
	2	1.2 (2.77)	75/63	7.1	6.3	8.3	0.41	17.4		60	5.8	4.4	0.44	3.9
			80/67	7.5	6.5	8.8	0.41	18.4		70	5.6	4.1	0.47	3.5
			85/71	8.0	6.8	9.3	0.41	19.8		80	5.4	3.8	0.50	3.1
	3	2.4 (5.54)	75/63	7.2	6.4	8.5	0.40	18.3		60	6.0	4.6	0.44	4.0
			80/67	7.7	6.6	9.0	0.39	19.8		70	5.8	4.3	0.47	3.6
			85/71	8.2	6.8	9.5	0.39	21.3		80	5.6	4.0	0.51	3.2
70	1	0.3 (0.6)	75/63	6.2	6.0	7.7	0.49	12.7	50	60	6.0	4.7	0.44	4.0
			80/67	6.7	6.2	8.2	0.50	13.6		70	5.9	4.4	0.47	3.6
			85/71	7.1	6.5	8.6	0.50	14.3		80	5.7	4.1	0.51	3.3
	2	1.1 (2.54)	75/63	6.6	6.1	8.0	0.45	14.7		60	6.7	5.3	0.44	4.4
			80/67	7.1	6.4	8.5	0.45	15.8		70	6.5	4.9	0.48	4.0
			85/71	7.6	6.6	9.0	0.45	17.0		80	6.3	4.6	0.52	3.6
	3	2.3 (5.31)	75/63	6.8	6.2	8.1	0.44	15.6		60	6.9	5.5	0.44	4.5
			80/67	7.3	6.4	8.6	0.44	16.8		70	6.7	5.2	0.48	4.1
			85/71	7.8	6.7	9.1	0.43	18.1		80	6.5	4.8	0.52	3.7
80	1	0.3 (0.6)	75/63	5.9	5.6	7.4	0.53	11.2	60	60	6.9	5.5	0.44	4.5
			80/67	6.3	6.1	7.8	0.54	11.8		70	6.7	5.2	0.48	4.1
			85/71	6.7	6.3	8.3	0.54	12.5		80	6.5	4.9	0.52	3.7
	2	1.1 (2.54)	75/63	6.2	6.0	7.7	0.50	12.6		60	7.6	6.2	0.45	5.0
			80/67	6.7	6.2	8.2	0.50	13.6		70	7.4	5.8	0.49	4.4
			85/71	7.1	6.5	8.6	0.50	14.4		80	7.1	5.4	0.53	3.9
	3	2.3 (5.31)	75/63	6.4	6.0	7.8	0.48	13.4		60	7.9	6.5	0.45	5.2
			80/67	6.8	6.3	8.3	0.48	14.2		70	7.7	6.1	0.49	4.6
			85/71	7.3	6.5	8.7	0.48	15.3		80	7.4	5.7	0.53	4.1
85	1	0.3 (0.6)	75/63	5.7	5.5	7.3	0.55	10.4	70	60	7.7	6.3	0.45	5.0
			80/67	6.1	5.8	7.7	0.56	11.0		70	7.6	6.0	0.49	4.6
			85/71	6.4	6.3	8.1	0.56	11.5		80	7.4	5.6	0.53	4.1
	2	1.1 (2.54)	75/63	6.0	5.7	7.6	0.52	11.7		60	8.6	7.2	0.45	5.6
			80/67	6.4	6.1	8.0	0.52	12.4		70	8.3	6.8	0.49	4.9
			85/71	6.9	6.4	8.4	0.52	13.4		80	8.1	6.3	0.53	4.4
	3	2.2 (5.07)	75/63	6.1	5.9	7.6	0.50	12.2		60	9.0	7.6	0.45	5.9
			80/67	6.6	6.2	8.1	0.50	13.2		70	8.7	7.1	0.49	5.2
			85/71	7.0	6.4	8.6	0.50	14.0		80	8.4	6.6	0.53	4.6
90	1	0.3 (0.6)	75/63	5.5	5.4	7.1	0.57	9.7	80	60	8.6	7.2	0.45	5.6
			80/67	5.9	5.7	7.5	0.58	10.3		70	8.4	6.9	0.49	5.0
			85/71	6.2	6.0	8.0	0.58	10.7		80	8.2	6.5	0.53	4.5
	2	1.1 (2.54)	75/63	5.8	5.6	7.4	0.54	10.8		60	9.6	8.2	0.45	6.3
			80/67	6.2	6.0	7.8	0.54	11.6		70	9.3	7.7	0.49	5.5
			85/71	6.6	6.3	8.3	0.54	12.3		80	9.0	7.3	0.54	4.9
	3	2.2 (5.07)	75/63	5.9	5.7	7.5	0.53	11.3		60	10.0	8.6	0.45	6.9
			80/67	6.3	6.1	7.9	0.53	12.0		70	9.7	8.1	0.49	5.8
			85/71	6.8	6.4	8.4	0.53	13.0		80	9.3	7.6	0.54	5.0
100	1	0.3 (0.6)	75/63	5.1	5.1	6.9	0.62	8.4	Extended Range - Anti-freeze required	AHRI/ISO13256-1 certified performance is rated at entering air conditions of 80.6°F DB and 66.2°F WB in cooling and 68°F DB in heating. Tabulated unit performance does not include fan or pump power corrections required for AHRI/ISO standard performance ratings. Unit performance may be interpolated. Extrapolation is not allowed. For conditions other than rating conditions provided, consult the BST selection software. Ratings below 40°F are with a methanol solution. The results reported herein are estimates based on testing by FHP. Variations in the installation and operational environment may alter performance. Bosch disclaims all warranties, express and implied, that the performance will be as reported, including the warranty of merchantability and fitness for purpose. In addition, continuous research and development may result in a change to an appliances design and specifications, which Bosch may change without notice. Before purchase, confirm the design specifications of the appliance.	FHP	AHRI CERTIFIED www.ahridirectory.org	ETL Intertek	
			80/67	5.4	5.4	7.2	0.62	8.8						
			85/71	5.8	5.8	7.6	0.63	9.3						
	2	1 (2.31)	75/63	5.4	5.4	7.1	0.58	9.3						
			80/67	5.8	5.7	7.5	0.59	10.0						
			85/71	6.2	5.9	7.9	0.59	10.6						
	3	2.1 (4.84)	75/63	5.5	5.4	7.1	0.57	9.7						
			80/67	5.9	5.7	7.6	0.58	10.3						
			85/71	6.3	6.0	8.0	0.58	11.0						
110	1	0.3 (0.6)	75/63	4.7	4.7	6.6	0.66	7.2						
			80/67	5.0	5.0	7.0	0.67	7.5						
			85/71	5.4	5.4	7.3	0.68	8.0						
	2	1 (2.31)	75/63	5.0	5.0	6.8	0.63	8.0						
			80/67	5.3	5.3	7.2	0.64	8.4						
			85/71	5.7	5.7	7.6	0.64	9.0						
	3	2.1 (4.84)	75/63	5.1	5.1	6.8	0.62	8.3						
			80/67	5.4	5.4	7.2	0.62	8.7						
			85/71	5.8	5.8	7.6	0.63	9.3						

Capacity Data

LV009 (350 CFM)

Cooling									Heating					
Entering Fluid Temp (°F)	Water Flow (GPM)	Pressure Drop PSI (FOH)	Entering Air Temp (db/wb) °F	Total Capacity (MBTUH)	Sensible Capacity (MBTUH)	Heat of Rejection (MBTUH)	Power Input (kW)	EER	Entering Fluid Temp (°F)	Entering Air Temp (°F)	Total Capacity (MBTUH)	Heat of Absorption (MBTUH)	Power Input (kW)	COP
50	1	0.5 (1.1)	75/63	9.1	7.7	10.6	0.52	17.6	30	60	5.8	4.2	0.54	3.1
			80/67	9.6	8.0	11.2	0.52	18.6		70	5.7	3.9	0.58	2.9
			85/71	10.2	8.2	11.8	0.52	19.8		80	5.6	3.7	0.63	2.6
	2	1.8 (4.15)	75/63	9.6	8.0	11.0	0.44	21.6		60	6.4	4.7	0.55	3.4
			80/67	10.3	8.2	11.7	0.44	23.6		70	6.3	4.4	0.59	3.1
			85/71	10.9	8.5	12.3	0.43	25.4		80	6.1	4.1	0.64	2.8
	3	3.8 (8.77)	75/63	9.8	8.0	11.1	0.42	23.5		60	6.7	5.0	0.55	3.6
			80/67	10.5	8.3	11.8	0.41	25.7		70	6.5	4.6	0.60	3.2
			85/71	11.2	8.6	12.5	0.40	28.2		80	6.4	4.3	0.64	2.9
60	1	0.5 (1.1)	75/63	8.6	7.5	10.4	0.57	15.1	40	60	6.8	5.1	0.55	3.6
			80/67	9.2	7.8	10.9	0.57	16.1		70	6.7	4.8	0.60	3.3
			85/71	9.7	8.1	11.5	0.57	16.9		80	6.5	4.5	0.65	2.9
	2	1.8 (4.15)	75/63	9.2	7.8	10.7	0.50	18.3		60	7.5	5.7	0.56	3.9
			80/67	9.8	8.0	11.3	0.50	19.7		70	7.3	5.4	0.61	3.5
			85/71	10.4	8.3	11.9	0.49	21.2		80	7.1	5.0	0.66	3.2
	3	3.6 (8.30)	75/63	9.4	7.8	10.8	0.48	19.7		60	7.8	6.0	0.57	4.1
			80/67	10.0	8.1	11.5	0.47	21.2		70	7.6	5.6	0.61	3.6
			85/71	10.6	8.4	12.1	0.46	22.9		80	7.4	5.2	0.67	3.3
70	1	0.5 (1.1)	75/63	8.2	7.2	10.0	0.62	13.1	50	60	7.7	6.0	0.57	4.0
			80/67	8.7	7.6	10.6	0.63	13.8		70	7.6	5.7	0.61	3.6
			85/71	9.3	7.9	11.2	0.63	14.7		80	7.5	5.3	0.67	3.3
	2	1.7 (3.92)	75/63	8.7	7.5	10.4	0.56	15.5		60	8.6	6.8	0.57	4.4
			80/67	9.3	7.9	11.0	0.56	16.6		70	8.4	6.4	0.62	4.0
			85/71	9.9	8.1	11.6	0.56	17.8		80	8.2	6.0	0.68	3.6
	3	3.5 (8.07)	75/63	8.9	7.6	10.5	0.54	16.5		60	9.0	7.2	0.57	4.6
			80/67	9.5	7.9	11.1	0.53	17.8		70	8.7	6.7	0.63	4.1
			85/71	10.1	8.2	11.8	0.53	19.1		80	8.5	6.3	0.68	3.7
80	1	0.5 (1.1)	75/63	7.7	7.0	9.7	0.68	11.3	60	60	8.8	7.0	0.57	4.5
			80/67	8.2	7.3	10.3	0.69	11.9		70	8.6	6.6	0.63	4.0
			85/71	8.7	7.5	10.8	0.69	12.6		80	8.5	6.2	0.68	3.7
	2	1.6 (3.69)	75/63	8.2	7.2	10.1	0.62	13.2		60	9.8	8.0	0.58	5.0
			80/67	8.8	7.6	10.6	0.62	14.1		70	9.5	7.5	0.63	4.4
			85/71	9.3	7.9	11.2	0.62	15.0		80	9.3	7.0	0.69	3.9
	3	3.4 (7.84)	75/63	8.4	7.2	10.2	0.60	14.0		60	10.2	8.4	0.58	5.2
			80/67	9.0	7.7	10.8	0.60	15.0		70	9.9	7.8	0.64	4.6
			85/71	9.6	8.0	11.4	0.60	16.1		80	9.6	7.3	0.70	4.1
85	1	0.5 (1.1)	75/63	7.5	6.9	9.6	0.71	10.6	70	60	9.8	8.0	0.58	5.0
			80/67	8.0	7.2	10.1	0.72	11.2		70	9.6	7.6	0.63	4.4
			85/71	8.5	7.4	10.7	0.72	11.8		80	9.4	7.2	0.69	4.0
	2	1.6 (3.69)	75/63	8.0	7.1	9.9	0.65	12.2		60	11.0	9.2	0.58	5.6
			80/67	8.5	7.3	10.5	0.65	13.0		70	10.7	8.6	0.64	4.9
			85/71	9.1	7.8	11.0	0.65	13.9		80	10.4	8.1	0.70	4.3
	3	3.3 (7.61)	75/63	8.1	7.1	10.0	0.63	12.8		60	11.6	9.7	0.58	5.9
			80/67	8.7	7.4	10.6	0.63	13.7		70	11.1	9.0	0.64	5.1
			85/71	9.3	7.9	11.2	0.63	14.8		80	10.8	8.5	0.71	4.5
90	1	0.5 (1.1)	75/63	7.3	6.7	9.4	0.74	9.9	80	60	10.9	9.1	0.58	5.5
			80/67	7.8	7.0	10.0	0.75	10.4		70	10.7	8.6	0.64	4.9
			85/71	8.2	7.3	10.5	0.75	10.9		80	10.4	8.2	0.70	4.3
	2	1.6 (3.69)	75/63	7.7	7.0	9.7	0.68	11.2		60	12.3	10.5	0.58	6.2
			80/67	8.2	7.3	10.3	0.69	11.9		70	11.8	9.8	0.65	5.4
			85/71	8.8	7.5	10.8	0.69	12.8		80	11.5	9.3	0.71	4.7
	3	3.3 (7.61)	75/63	7.8	7.0	9.8	0.67	11.7		60	12.9	11.1	0.58	6.5
			80/67	8.4	7.3	10.4	0.67	12.6		70	12.3	10.2	0.65	5.6
			85/71	9.0	7.8	11.0	0.66	13.6		80	12.0	9.8	0.72	4.9
100	1	0.4 (0.9)	75/63	6.8	6.5	9.1	0.80	8.5	Extended Range - Anti-freeze required					
			80/67	7.2	6.8	9.6	0.81	8.9		AHRI/ISO13256-1 certified performance is rated at entering air conditions of 80.6°F DB and 66.2°F WB in cooling and 68°F DB in heating.				
			85/71	7.7	7.1	10.1	0.82	9.4		Tabulated unit performance does not include fan or pump power corrections required for AHRI/ISO standard performance ratings.				
	2	1.5 (3.47)	75/63	7.2	6.7	9.4	0.75	9.6		Unit performance may be interpolated. Extrapolation is not allowed.				
			80/67	7.7	7.1	9.9	0.75	10.2		For conditions other than rating conditions provided, consult the BST selection software.				
			85/71	8.2	7.3	10.5	0.75	10.9		Ratings below 40°F are with a methanol solution.				
	3	3.2 (7.39)	75/63	7.3	6.8	9.5	0.73	10.0		The results reported herein are estimates based on testing by FHP. Variations in the installation and operational environment may alter performance. Bosch disclaims all warranties, express and implied, that the performance will be as reported, including the warranty of merchantability and fitness for purpose. In addition, continuous research and development may result in a change to an appliances design and specifications, which Bosch may change without notice. Before purchase, confirm the design specifications of the appliance.				
			80/67	7.9	7.1	10.0	0.73	10.8						
			85/71	8.4	7.3	10.6	0.73	11.4						
110	1	0.4 (0.9)	75/63	6.3	6.3	8.8	0.86	7.3						
			80/67	6.7	6.6	9.3	0.87	7.7						
			85/71	7.2	6.9	9.8	0.88	8.1						
	2	1.5 (3.47)	75/63	6.7	6.5	9.0	0.82	8.2						
			80/67	7.1	6.8	9.6	0.82	8.6						
			85/71	7.6	7.1	10.1	0.83	9.2						
	3	3.1 (7.15)	75/63	6.8	6.6	9.1	0.80	8.5						
			80/67	7.3	6.9	9.6	0.80	9.1						
			85/71	7.8	7.2	10.2	0.81	9.7						

Extended Range - Anti-freeze required
 AHRI/ISO13256-1 certified performance is rated at entering air conditions of 80.6°F DB and 66.2°F WB in cooling and 68°F DB in heating.
 Tabulated unit performance does not include fan or pump power corrections required for AHRI/ISO standard performance ratings.
 Unit performance may be interpolated. Extrapolation is not allowed.
 For conditions other than rating conditions provided, consult the BST selection software.
 Ratings below 40°F are with a methanol solution.
 The results reported herein are estimates based on testing by FHP. Variations in the installation and operational environment may alter performance. Bosch disclaims all warranties, express and implied, that the performance will be as reported, including the warranty of merchantability and fitness for purpose. In addition, continuous research and development may result in a change to an appliances design and specifications, which Bosch may change without notice. Before purchase, confirm the design specifications of the appliance.



Capacity Data

LV012 (400 CFM)

Cooling									Heating					
Entering Fluid Temp (°F)	Water Flow (GPM)	Pressure Drop PSI (FOH)	Entering Air Temp (db/wb) °F	Total Capacity (MBTUH)	Sensible Capacity (MBTUH)	Heat of Rejection (MBTUH)	Power Input (kW)	EER	Entering Fluid Temp (°F)	Entering Air Temp (°F)	Total Capacity (MBTUH)	Heat of Absorption (MBTUH)	Power Input (kW)	COP
50	1.5	1.1 (2.54)	75/63	12.5	9.7	14.6	0.67	18.8						
			80/67	13.3	10.0	15.4	0.67	19.9						
			85/71	14.1	10.2	16.3	0.67	21.0						
	2.5	2.8 (6.46)	75/63	12.9	9.9	14.9	0.61	21.3						
			80/67	13.8	10.2	15.8	0.60	22.9						
			85/71	14.7	10.4	16.7	0.60	24.6						
	3.5	5.1 (11.7)	75/63	13.1	10.0	15.0	0.58	22.6						
			80/67	14.0	10.3	15.9	0.57	24.4						
			85/71	15.0	10.6	16.9	0.57	26.6						
60	1.5	1.1 (2.54)	75/63	11.9	9.4	14.2	0.74	16.1						
			80/67	12.7	9.7	15.0	0.75	17.1						
			85/71	13.5	10.0	15.9	0.75	18.0						
	2.5	2.7 (6.23)	75/63	12.3	9.6	14.5	0.69	18.0						
			80/67	13.2	9.9	15.4	0.68	19.4						
			85/71	14.1	10.2	16.3	0.68	20.8						
	3.5	4.9 (11.2)	75/63	12.5	9.7	14.6	0.66	18.9						
			80/67	13.4	10.0	15.5	0.66	20.5						
			85/71	14.3	10.3	16.4	0.65	22.0						
70	1.5	1 (2.3)	75/63	11.3	9.2	13.8	0.82	13.9						
			80/67	12.0	9.5	14.6	0.82	14.6						
			85/71	12.8	9.8	15.4	0.83	15.4						
	2.5	2.6 (5.9)	75/63	11.7	9.4	14.1	0.76	15.3						
			80/67	12.5	9.7	14.9	0.77	16.4						
			85/71	13.3	10.0	15.8	0.76	17.4						
	3.5	4.8 (11.0)	75/63	11.8	9.4	14.2	0.75	15.9						
			80/67	12.7	9.8	15.1	0.74	17.2						
			85/71	13.6	10.0	15.9	0.74	18.4						
80	1.5	1 (2.3)	75/63	10.7	8.9	13.5	0.89	12.0						
			80/67	11.4	9.2	14.2	0.90	12.6						
			85/71	12.1	9.5	15.0	0.91	13.3						
	2.5	2.5 (5.7)	75/63	11.1	9.1	13.7	0.85	13.1						
			80/67	11.8	9.4	14.5	0.85	13.9						
			85/71	12.6	9.7	15.3	0.85	14.8						
	3.5	4.6 (10.6)	75/63	11.2	9.2	13.8	0.83	13.5						
			80/67	12.0	9.4	14.6	0.83	14.5						
			85/71	12.8	9.7	15.5	0.83	15.5						
85	1.5	1 (2.3)	75/63	10.4	8.8	13.3	0.93	11.2						
			80/67	11.1	9.1	14.0	0.94	11.8						
			85/71	11.8	9.4	14.8	0.95	12.4						
	2.5	2.5 (5.7)	75/63	10.7	9.0	13.5	0.89	12.1						
			80/67	11.5	9.3	14.3	0.89	12.9						
			85/71	12.2	9.6	15.1	0.90	13.6						
	3.5	4.5 (10.3)	75/63	10.9	9.0	13.5	0.87	12.6						
			80/67	11.6	9.3	14.4	0.87	13.3						
			85/71	12.4	9.6	15.2	0.88	14.2						
90	1.5	1 (2.3)	75/63	10.1	8.7	13.1	0.98	10.4						
			80/67	10.7	9.0	13.8	0.99	10.9						
			85/71	11.5	9.3	14.6	1.00	11.6						
	2.5	2.4 (5.5)	75/63	10.4	8.8	13.3	0.93	11.2						
			80/67	11.1	9.1	14.1	0.94	11.9						
			85/71	11.9	9.4	14.8	0.94	12.6						
	3.5	4.5 (10.3)	75/63	10.5	8.8	13.4	0.92	11.4						
			80/67	11.3	9.2	14.1	0.91	12.4						
			85/71	12.1	9.5	14.9	0.92	13.2						
100	1.5	0.9 (2.0)	75/63	9.4	8.4	12.6	1.06	8.9						
			80/67	10.1	8.8	13.4	1.07	9.4						
			85/71	10.8	9.0	14.1	1.08	10.0						
	2.5	2.4 (5.5)	75/63	9.7	8.5	12.8	1.02	9.5						
			80/67	10.4	8.8	13.6	1.03	10.1						
			85/71	11.1	9.2	14.3	1.03	10.7						
	3.5	4.3 (9.9)	75/63	9.8	8.6	12.9	1.01	9.8						
			80/67	10.5	8.9	13.6	1.01	10.5						
			85/71	11.3	9.3	14.4	1.01	11.2						
110	1.5	0.9 (2.0)	75/63	8.8	8.1	12.2	1.15	7.7						
			80/67	9.4	8.5	12.9	1.16	8.1						
			85/71	10.0	8.8	13.6	1.17	8.6						
	2.5	2.3 (5.3)	75/63	9.0	8.3	12.4	1.11	8.1						
			80/67	9.7	8.5	13.1	1.12	8.7						
			85/71	10.4	8.9	13.9	1.13	9.2						
	3.5	4.2 (9.6)	75/63	9.1	8.3	12.5	1.10	8.3						
			80/67	9.8	8.7	13.2	1.10	8.9						
			85/71	10.5	9.0	13.9	1.11	9.5						

Extended Range - Anti-freeze required
 AHRI/ISO13256-1 certified performance is rated at entering air conditions of 80.6°F DB and 66.2°F WB in cooling and 68°F DB in heating.
 Tabulated unit performance does not include fan or pump power corrections required for AHRI/ISO standard performance ratings.
 Unit performance may be interpolated. Extrapolation is not allowed.
 For conditions other than rating conditions provided, consult the BST selection software.
 Ratings below 40°F are with a methanol solution.
 The results reported herein are estimates based on testing by FHP. Variations in the installation and operational environment may alter performance. Bosch disclaims all warranties, express and implied, that the performance will be as reported, including the warranty of merchantability and fitness for purpose. In addition, continuous research and development may result in a change to an appliances design and specifications, which Bosch may change without notice. Before purchase, confirm the design specifications of the appliance.



Capacity Data

LV015 (500 CFM)

Cooling									Heating															
Entering Fluid Temp (°F)	Water Flow (GPM)	Pressure Drop PSI (FOH)	Entering Air Temp (db/wb) °F	Total Capacity (MBTUH)	Sensible Capacity (MBTUH)	Heat of Rejection (MBTUH)	Power Input (kW)	EER	Entering Fluid Temp (°F)	Entering Air Temp (°F)	Total Capacity (MBTUH)	Heat of Absorption (MBTUH)	Power Input (kW)	COP										
50	2	2 (4.62)	75/63	15.2	11.5	17.7	0.77	19.8	30	60	10.1	7.1	0.93	3.2										
			80/67	16.3	11.9	18.7	0.76	21.5		70	9.9	6.7	1.00	2.9										
			85/71	17.3	12.3	19.8	0.75	23.2		80	9.9	6.2	1.08	2.7										
	3	4.2 (9.6)	75/63	15.6	11.7	17.9	0.71	21.9		60	10.5	7.5	0.94	3.3										
			80/67	16.7	12.1	19.0	0.70	24.0		70	10.3	7.1	1.01	3.0										
			85/71	17.9	12.5	20.1	0.68	26.4		80	10.3	6.5	1.09	2.8										
	4.5	8.6 (19.8)	75/63	15.9	11.9	18.1	0.67	23.6		60	10.8	7.8	0.94	3.4										
			80/67	17.1	12.3	19.2	0.65	26.2		70	10.6	7.3	1.02	3.0										
			85/71	18.3	12.7	20.4	0.63	29.0		80	10.6	6.7	1.10	2.8										
60	2	1.9 (4.3)	75/63	14.5	11.2	17.3	0.86	16.8	40	60	11.6	8.5	0.96	3.6										
			80/67	15.5	11.6	18.3	0.86	18.1		70	11.3	8.0	1.04	3.2										
			85/71	16.6	12.0	19.3	0.85	19.6		80	11.1	7.5	1.12	2.9										
	3	4 (9.2)	75/63	14.9	11.4	17.5	0.81	18.4		60	12.0	9.0	0.96	3.6										
			80/67	16.0	11.8	18.6	0.80	20.1		70	11.8	8.4	1.05	3.3										
			85/71	17.1	12.2	19.6	0.78	21.9		80	11.6	7.9	1.13	3.0										
	4.5	8.3 (19.1)	75/63	15.2	11.5	17.7	0.77	19.6		60	12.5	9.4	0.97	3.8										
			80/67	16.3	11.9	18.7	0.76	21.5		70	12.2	8.8	1.06	3.4										
			85/71	17.4	12.3	19.8	0.74	23.6		80	12.1	8.0	1.14	3.1										
70	2	1.9 (4.3)	75/63	13.8	11.0	16.8	0.96	14.4	50	60	13.2	9.9	0.98	3.9										
			80/67	14.8	11.3	17.8	0.96	15.5		70	13.2	9.3	1.07	3.6										
			85/71	15.8	11.7	18.8	0.95	16.6		80	12.7	8.7	1.16	3.2										
	3	3.9 (8.9)	75/63	14.2	11.1	17.0	0.91	15.6		60	13.7	10.7	0.99	4.0										
			80/67	15.2	11.5	18.1	0.90	16.9		70	13.4	10.0	1.08	3.7										
			85/71	16.3	11.9	19.1	0.89	18.3		80	13.1	9.3	1.17	3.3										
	4.5	8.1 (18.6)	75/63	14.4	11.2	17.2	0.88	16.4		60	14.2	11.1	1.00	4.2										
			80/67	15.5	11.6	18.2	0.86	18.0		70	13.9	10.3	1.08	3.8										
			85/71	16.6	12.0	19.3	0.85	19.6		80	13.5	9.7	1.17	3.4										
80	2	1.8 (4.1)	75/63	13.0	10.6	16.4	1.06	12.3	60	60	14.8	11.6	1.00	4.3										
			80/67	14.0	11.1	17.3	1.06	13.2		70	14.5	11.0	1.09	3.9										
			85/71	14.9	11.4	18.3	1.06	14.1		80	14.1	10.3	1.18	3.5										
	3	3.8 (8.7)	75/63	13.4	10.7	16.6	1.01	13.2		60	15.8	12.2	1.01	4.6										
			80/67	14.4	11.2	17.5	1.01	14.3		70	15.4	11.4	1.10	4.1										
			85/71	15.4	11.6	18.6	1.00	15.4		80	14.8	10.9	1.19	3.6										
	4.5	7.8 (17.9)	75/63	13.6	10.9	16.7	0.98	13.8		60	16.4	12.7	1.01	4.7										
			80/67	14.6	11.2	17.7	0.97	15.0		70	16.0	11.8	1.11	4.2										
			85/71	15.7	11.7	18.7	0.96	16.3		80	15.3	11.3	1.20	3.7										
85	2	1.8 (4.1)	75/63	12.7	10.4	16.1	1.11	11.4	70	60	16.5	13.4	1.02	4.8										
			80/67	13.6	10.9	17.0	1.11	12.2		70	16.5	12.4	1.11	4.4										
			85/71	14.5	11.3	18.0	1.11	13.1		80	16.0	11.7	1.21	3.9										
	3	3.7 (8.5)	75/63	13.0	10.6	16.3	1.07	12.2		60	17.7	14.0	1.02	5.1										
			80/67	13.9	11.1	17.3	1.06	13.1		70	17.5	13.0	1.12	4.6										
			85/71	15.0	11.4	18.3	1.05	14.2		80	17.1	12.1	1.22	4.1										
	4.5	7.7 (17.7)	75/63	13.2	10.7	16.4	1.04	12.7		60	18.0	14.8	1.02	5.2										
			80/67	14.2	11.1	17.4	1.03	13.8		70	17.9	13.6	1.13	4.7										
			85/71	15.2	11.5	18.5	1.02	14.9		80	17.4	12.7	1.23	4.2										
90	2	1.8 (4.1)	75/63	12.3	10.3	15.9	1.16	10.6	80	60	18.4	14.9	1.03	5.3										
			80/67	13.2	10.7	16.8	1.16	11.3		70	18.2	14.1	1.13	4.7										
			85/71	14.1	11.1	17.8	1.16	12.1		80	18.0	13.0	1.23	4.3										
	3	3.6 (8.3)	75/63	12.6	10.4	16.1	1.12	11.3		60	19.6	15.9	1.03	5.6										
			80/67	13.5	10.9	17.0	1.12	12.1		70	19.1	15.0	1.14	4.9										
			85/71	14.5	11.3	18.0	1.11	13.1		80	18.9	13.9	1.24	4.5										
	4.5	7.6 (17.5)	75/63	12.8	10.6	16.2	1.09	11.7		60	20.4	16.5	1.03	5.8										
			80/67	13.8	10.9	17.2	1.09	12.7		70	19.8	15.6	1.14	5.1										
			85/71	14.8	11.4	18.2	1.08	13.8		80	19.5	14.4	1.25	4.6										
100	2	1.7 (3.9)	75/63	11.5	9.9	15.4	1.27	9.1	Extended Range - Anti-freeze required	AHRI/ISO13256-1 certified performance is rated at entering air conditions of 80.6°F DB and 66.2°F WB in cooling and 68°F DB in heating.	Tabulated unit performance does not include fan or pump power corrections required for AHRI/ISO standard performance ratings.	Unit performance may be interpolated. Extrapolation is not allowed.	For conditions other than rating conditions provided, consult the BST selection software.	Ratings below 40°F are with a methanol solution.	The results reported herein are estimates based on testing by FHP. Variations in the installation and operational environment may alter performance. Bosch disclaims all warranties, express and implied, that the performance will be as reported, including the warranty of merchantability and fitness for purpose. In addition, continuous research and development may result in a change to an appliances design and specifications, which Bosch may change without notice. Before purchase, confirm the design specifications of the appliance.									
			80/67	12.3	10.4	16.3	1.27	9.7																
			85/71	13.2	10.8	17.2	1.27	10.4																
	3	3.5 (8.0)	75/63	11.8	10.0	15.6	1.23	9.6								110	2	1.7 (3.9)	75/63	11.0	9.7	15.1	1.34	8.2
			80/67	12.7	10.5	16.5	1.23	10.4											80/67	11.8	10.2	16.0	1.34	8.8
			85/71	13.6	10.9	17.5	1.23	11.1											85/71	12.7	10.6	16.9	1.34	9.5
	4.5	7.3 (16.8)	75/63	12.0	10.1	15.7	1.21	9.9									75/63	11.1	9.8	15.2	1.32	8.4		
			80/67	12.9	10.6	16.6	1.20	10.8									80/67	12.0	10.3	16.1	1.32	9.1		
			85/71	13.9	11.0	17.6	1.20	11.6									85/71	12.9	10.7	17.0	1.31	9.8		

Extended Range - Anti-freeze required

AHRI/ISO13256-1 certified performance is rated at entering air conditions of 80.6°F DB and 66.2°F WB in cooling and 68°F DB in heating.

Tabulated unit performance does not include fan or pump power corrections required for AHRI/ISO standard performance ratings.

Unit performance may be interpolated. Extrapolation is not allowed.

For conditions other than rating conditions provided, consult the BST selection software.

Ratings below 40°F are with a methanol solution.

The results reported herein are estimates based on testing by FHP. Variations in the installation and operational environment may alter performance. Bosch disclaims all warranties, express and implied, that the performance will be as reported, including the warranty of merchantability and fitness for purpose. In addition, continuous research and development may result in a change to an appliances design and specifications, which Bosch may change without notice. Before purchase, confirm the design specifications of the appliance.



Capacity Data

LV024 (850 CFM)

Cooling									Heating					
Entering Fluid Temp (°F)	Water Flow (GPM)	Pressure Drop PSI (FOH)	Entering Air Temp (db/wb) °F	Total Capacity (MBTUH)	Sensible Capacity (MBTUH)	Heat of Rejection (MBTUH)	Power Input (kW)	EER	Entering Fluid Temp (°F)	Entering Air Temp (°F)	Total Capacity (MBTUH)	Heat of Absorption (MBTUH)	Power Input (kW)	COP
50	3	1.8 (4.1)	75/63	25.6	18.6	30.0	1.44	17.8						
			80/67	27.5	19.2	32.0	1.45	19.0						
			85/71	29.5	19.8	34.0	1.45	20.4						
	5	4.5 (10.3)	75/63	26.9	19.1	31.0	1.33	20.2						
			80/67	28.9	19.8	33.1	1.33	21.8						
			85/71	31.1	20.4	35.3	1.31	23.7						
	7	8.2 (18.9)	75/63	27.5	19.4	31.5	1.28	21.5						
			80/67	29.6	20.1	33.6	1.27	23.4						
			85/71	31.8	20.7	35.8	1.25	25.5						
60	3	1.7 (3.9)	75/63	24.3	18.0	29.0	1.55	15.7						
			80/67	26.1	18.6	30.9	1.56	16.7						
			85/71	28.0	19.2	32.9	1.58	17.8						
	5	4.3 (9.8)	75/63	25.5	18.5	29.9	1.45	17.6						
			80/67	27.5	19.2	32.0	1.45	19.0						
			85/71	29.6	19.8	34.1	1.45	20.5						
	7	7.9 (18.2)	75/63	26.1	18.8	30.4	1.40	18.6						
			80/67	28.1	19.4	32.5	1.40	20.1						
			85/71	30.3	20.1	34.6	1.38	21.9						
70	3	1.7 (3.9)	75/63	22.9	17.3	27.9	1.66	13.8						
			80/67	24.7	18.0	29.8	1.68	14.7						
			85/71	26.5	18.6	31.7	1.70	15.6						
	5	4.2 (9.6)	75/63	24.1	17.8	28.8	1.57	15.4						
			80/67	26.0	18.5	30.8	1.58	16.5						
			85/71	27.9	19.2	32.8	1.58	17.6						
	7	7.7 (17.7)	75/63	24.6	18.1	29.2	1.53	16.1						
			80/67	26.6	18.8	31.3	1.53	17.4						
			85/71	28.6	19.4	33.4	1.53	18.8						
80	3	1.6 (3.6)	75/63	21.5	16.6	26.7	1.77	12.1						
			80/67	23.1	17.3	28.5	1.80	12.8						
			85/71	24.9	17.9	30.4	1.83	13.6						
	5	4 (9.2)	75/63	22.5	17.2	27.6	1.69	13.3						
			80/67	24.4	17.8	29.5	1.71	14.3						
			85/71	26.3	18.5	31.5	1.72	15.3						
	7	7.4 (17.0)	75/63	23.0	17.4	28.0	1.65	13.9						
			80/67	24.9	18.0	30.0	1.66	15.0						
			85/71	26.9	18.7	32.0	1.67	16.1						
85	3	1.6 (3.6)	75/63	20.7	16.3	26.1	1.83	11.3						
			80/67	22.4	17.0	27.9	1.86	12.1						
			85/71	24.1	17.6	29.7	1.89	12.8						
	5	4 (9.2)	75/63	21.8	16.8	26.9	1.75	12.5						
			80/67	23.5	17.5	28.9	1.77	13.3						
			85/71	25.4	18.1	30.8	1.79	14.2						
	7	7.3 (16.8)	75/63	22.2	17.0	27.3	1.71	13.0						
			80/67	24.1	17.7	29.3	1.73	13.9						
			85/71	26.0	18.3	31.3	1.74	14.9						
90	3	1.6 (3.6)	75/63	20.0	15.9	25.5	1.88	10.7						
			80/67	21.5	16.7	27.2	1.92	11.2						
			85/71	23.2	17.2	29.1	1.95	11.9						
	5	3.9 (8.9)	75/63	21.0	16.4	26.3	1.81	11.6						
			80/67	22.7	17.1	28.2	1.84	12.4						
			85/71	24.5	17.7	30.1	1.86	13.2						
	7	7.2 (16.6)	75/63	21.4	16.6	26.7	1.78	12.1						
			80/67	23.2	17.3	28.6	1.80	12.9						
			85/71	25.1	17.9	30.6	1.81	13.9						
100	3	1.5 (3.4)	75/63	18.4	15.2	24.1	1.98	9.3						
			80/67	19.9	15.9	25.8	2.03	9.8						
			85/71	21.4	16.6	27.6	2.07	10.3						
	5	3.8 (8.7)	75/63	19.3	15.7	24.9	1.92	10.1						
			80/67	20.9	16.4	26.7	1.96	10.7						
			85/71	22.6	17.1	28.6	1.99	11.4						
	7	7 (16.1)	75/63	19.7	15.9	25.2	1.89	10.4						
			80/67	21.4	16.6	27.1	1.93	11.1						
			85/71	23.2	17.3	29.0	1.95	11.9						
110	3	1.5 (3.4)	75/63	16.7	14.6	22.6	2.08	8.1						
			80/67	18.1	15.3	24.3	2.13	8.5						
			85/71	19.5	15.9	26.0	2.19	8.9						
	5	3.7 (8.5)	75/63	17.5	15.0	23.4	2.03	8.6						
			80/67	19.1	15.6	25.2	2.08	9.2						
			85/71	20.7	16.3	27.0	2.12	9.8						
	7	6.8 (15.6)	75/63	17.9	15.1	23.7	2.01	8.9						
			80/67	19.6	15.8	25.6	2.05	9.6						
			85/71	21.2	16.6	27.4	2.09	10.2						
30	30	60	15.3	11.2	1.37	3.3								
		70	14.6	10.3	1.43	3.0								
		80	13.9	9.3	1.48	2.7								
		60	16.3	12.0	1.42	3.4								
		70	15.5	11.1	1.47	3.1								
		80	14.7	10.0	1.52	2.8								
		60	16.8	12.5	1.44	3.4								
		70	15.9	11.5	1.50	3.1								
		80	15.1	10.4	1.55	2.9								
40	40	60	18.0	13.4	1.48	3.6								
		70	17.2	12.5	1.55	3.3								
		80	16.4	11.5	1.61	3.0								
		60	19.3	14.6	1.53	3.7								
		70	18.4	13.5	1.60	3.4								
		80	17.5	12.5	1.66	3.1								
		60	20.0	15.2	1.55	3.8								
		70	19.0	14.0	1.62	3.4								
		80	18.1	12.9	1.68	3.2								
50	50	60	20.9	16.0	1.58	3.9								
		70	20.1	14.9	1.66	3.5								
		80	19.6	13.7	1.73	3.3								
		60	22.4	17.5	1.63	4.0								
		70	21.5	16.2	1.71	3.7								
		80	21.0	14.8	1.79	3.4								
		60	23.3	18.1	1.66	4.1								
		70	22.2	16.8	1.74	3.7								
		80	21.6	15.2	1.82	3.5								
60	60	60	24.0	18.7	1.68	4.2								
		70	23.1	17.6	1.77	3.8								
		80	22.6	16.2	1.86	3.6								
		60	25.8	20.4	1.73	4.4								
		70	24.8	19.2	1.83	4.0								
		80	24.2	17.4	1.92	3.7								
		60	26.8	21.3	1.75	4.5								
		70	25.7	19.9	1.86	4.1								
		80	24.5	18.4	1.95	3.7								
70	70	60	27.1	21.6	1.76	4.5								
		70	26.2	20.4	1.87	4.1								
		80	25.2	19.1	1.98	3.7								
		60	29.3	23.6	1.82	4.7								
		70	28.2	22.1	1.93	4.3								
		80	27.0	20.6	2.04	3.9								
		60	30.4	24.6	1.84	4.8								
		70	29.2	23.0	1.96	4.4								
		80	27.9	21.3	2.07	3.9								
80	80	60	30.4	24.6	1.84	4.8								
		70	29.4	23.2	1.97	4.4								
		80	28.3	21.8	2.09	4.0								
		60	32.8	26.9	1.89	5.1								
		70	31.6	25.2	2.02	4.6								
		80	30.3	23.5	2.15	4.1								
		60	34.0	28.0	1.91	5.2								
		70	32.7	26.2	2.05	4.7								
		80	31.3	24.3	2.18	4.2								

Extended Range - Anti-freeze required
 AHRI/ISO13256-1 certified performance is rated at entering air conditions of 80.6°F DB and 66.2°F WB in cooling and 68°F DB in heating.
 Tabulated unit performance does not include fan or pump power corrections required for AHRI/ISO standard performance ratings.
 Unit performance may be interpolated. Extrapolation is not allowed.
 For conditions other than rating conditions provided, consult the BST selection software.
 Ratings below 40°F are with a methanol solution.
 The results reported herein are estimates based on testing by FHP. Variations in the installation and operational environment may alter performance. Bosch disclaims all warranties, express and implied, that the performance will be as reported, including the warranty of merchantability and fitness for purpose. In addition, continuous research and development may result in a change to an appliances design and specifications, which Bosch may change without notice. Before purchase, confirm the design specifications of the appliance.



Capacity Data

LV036 (1200 CFM)

Cooling									Heating						
Entering Fluid Temp (°F)	Water Flow (GPM)	Pressure Drop PSI (FOH)	Entering Air Temp (db/wb) °F	Total Capacity (MBTUH)	Sensible Capacity (MBTUH)	Heat of Rejection (MBTUH)	Power Input (kW)	EER	Entering Fluid Temp (°F)	Entering Air Temp (°F)	Total Capacity (MBTUH)	Heat of Absorption (MBTUH)	Power Input (kW)	COP	
50	4	1.3 (2.9)	75/63	40.8	30.0	47.7	2.16	18.9	30	60	23.5	17.0	2.00	3.5	
			80/67	43.7	31.0	50.7	2.17	20.1		70	22.4	15.7	2.09	3.2	
			85/71	46.7	31.9	53.7	2.18	21.4		80	20.9	13.5	2.15	2.9	
	7.5	4.2 (9.6)	75/63	43.4	31.0	49.7	1.96	22.1		60	25.2	18.7	2.07	3.6	
			80/67	46.7	32.0	53.0	1.95	24.0		70	24.0	17.3	2.17	3.2	
			85/71	50.0	32.9	56.3	1.93	25.9		80	22.7	15.7	2.25	3.0	
	11	8.3 (19.1)	75/63	44.4	31.5	50.4	1.88	23.6		60	26.5	19.6	2.11	3.7	
			80/67	47.8	32.4	53.8	1.86	25.7		70	25.0	18.1	2.21	3.3	
			85/71	51.3	33.5	57.2	1.83	28.0		80	23.7	16.5	2.30	3.0	
60	4	1.3 (2.9)	75/63	38.7	29.1	46.0	2.33	16.6	40	60	27.2	20.5	2.15	3.7	
			80/67	41.5	30.0	49.0	2.35	17.6		70	26.3	18.9	2.26	3.4	
			85/71	44.5	30.8	52.0	2.37	18.8		80	25.5	16.8	2.35	3.2	
	7.5	4 (9.6)	75/63	41.2	30.1	47.9	2.14	19.3		60	29.9	22.7	2.24	3.9	
			80/67	44.3	31.1	51.1	2.13	20.8		70	28.6	21.0	2.35	3.6	
			85/71	47.6	32.0	54.4	2.12	22.4		80	27.2	19.2	2.45	3.3	
	11	8 (18.4)	75/63	42.1	30.5	48.7	2.06	20.4		60	31.0	23.7	2.27	4.0	
			80/67	45.4	31.5	51.9	2.05	22.2		70	29.6	22.0	2.39	3.6	
			85/71	48.8	32.4	55.3	2.02	24.1		80	28.3	20.3	2.50	3.3	
70	4	1.3 (2.9)	75/63	36.5	28.0	44.4	2.51	14.5	50	60	31.9	24.2	2.29	4.1	
			80/67	39.3	28.9	47.2	2.54	15.5		70	30.8	22.6	2.42	3.7	
			85/71	42.0	29.8	50.1	2.56	16.4		80	29.3	21.1	2.54	3.4	
	7.5	3.9 (8.9)	75/63	38.9	29.0	46.2	2.33	16.7		60	35.0	27.2	2.39	4.3	
			80/67	41.9	30.0	49.3	2.33	18.0		70	33.9	25.2	2.52	3.9	
			85/71	45.0	31.1	52.4	2.32	19.3		80	32.2	22.8	2.64	3.6	
	11	7.8 (17.9)	75/63	39.8	29.4	46.9	2.25	17.7		60	36.9	28.3	2.42	4.5	
			80/67	42.9	30.4	50.0	2.25	19.1		70	35.6	25.8	2.56	4.1	
			85/71	46.2	31.3	53.3	2.23	20.7		80	33.1	24.8	2.69	3.6	
80	4	1.2 (2.7)	75/63	34.3	27.0	42.6	2.69	12.8	60	60	36.6	28.3	2.42	4.4	
			80/67	36.9	28.0	45.4	2.73	13.5		70	35.4	26.6	2.57	4.0	
			85/71	39.4	29.1	48.1	2.76	14.3		80	33.8	24.9	2.71	3.7	
	7.5	3.8 (8.7)	75/63	36.5	27.9	44.3	2.52	14.5		60	40.2	32.0	2.52	4.7	
			80/67	39.3	29.0	47.3	2.53	15.5		70	37.4	29.0	2.66	4.1	
			85/71	42.3	30.1	50.3	2.54	16.7		80	36.9	27.9	2.83	3.8	
	11	7.5 (17.2)	75/63	37.3	28.3	45.0	2.45	15.2		60	41.9	33.9	2.56	4.8	
			80/67	40.3	29.5	48.0	2.46	16.4		70	40.7	31.1	2.72	4.4	
			85/71	43.4	30.3	51.2	2.45	17.7		80	38.3	29.3	2.88	3.9	
85	4	1.2 (2.7)	75/63	33.1	26.5	41.7	2.77	11.9	70	60	41.4	32.7	2.54	4.8	
			80/67	35.6	27.5	44.4	2.82	12.6		70	39.9	30.9	2.71	4.3	
			85/71	38.2	28.4	47.1	2.86	13.4		80	38.7	29.0	2.88	3.9	
	7.5	3.7 (8.5)	75/63	35.2	27.5	43.3	2.61	13.5		60	46.0	36.9	2.64	5.1	
			80/67	38.0	28.4	46.3	2.64	14.4		70	44.4	34.6	2.82	4.6	
			85/71	41.0	29.4	49.3	2.65	15.5		80	42.9	32.0	3.00	4.2	
	11	7.4 (17.0)	75/63	36.0	27.7	44.0	2.55	14.1		60	48.1	38.7	2.67	5.3	
			80/67	39.0	28.8	47.0	2.56	15.2		70	46.7	35.7	2.86	4.8	
			85/71	42.0	30.0	50.0	2.56	16.4		80	44.7	33.2	3.04	4.3	
90	4	1.2 (2.7)	75/63	31.9	26.1	40.6	2.86	11.1	80	60	46.3	37.3	2.64	5.1	
			80/67	34.3	27.2	43.3	2.91	11.8		70	44.6	35.2	2.83	4.6	
			85/71	36.8	28.2	46.0	2.95	12.5		80	43.3	33.1	3.02	4.2	
	7.5	3.6 (8.3)	75/63	34.0	26.9	42.3	2.71	12.5		60	51.5	42.1	2.73	5.5	
			80/67	36.6	28.1	45.2	2.74	13.4		70	49.2	39.5	2.94	4.9	
			85/71	39.5	28.9	48.2	2.76	14.3		80	47.2	37.0	3.13	4.4	
	11	7.3 (16.8)	75/63	34.7	27.2	42.9	2.65	13.1		60	53.8	44.2	2.76	5.7	
			80/67	37.5	28.4	45.9	2.67	14.0		70	52.3	40.8	2.97	5.2	
			85/71	40.5	29.5	48.9	2.68	15.1		80	49.3	39.0	3.18	4.5	
100	4	1.1 (2.5)	75/63	29.5	25.0	38.7	3.03	9.7	Extended Range - Anti-freeze required	AHRI/ISO13256-1 certified performance is rated at entering air conditions of 80.6°F DB and 66.2°F WB in cooling and 68°F DB in heating. Tabulated unit performance does not include fan or pump power corrections required for AHRI/ISO standard performance ratings. Unit performance may be interpolated. Extrapolation is not allowed. For conditions other than rating conditions provided, consult the BST selection software. Ratings below 40°F are with a methanol solution. The results reported herein are estimates based on testing by FHP. Variations in the installation and operational environment may alter performance. Bosch disclaims all warranties, express and implied, that the performance will be as reported, including the warranty of merchantability and fitness for purpose. In addition, continuous research and development may result in a change to an appliances design and specifications, which Bosch may change without notice. Before purchase, confirm the design specifications of the appliance.	60	23.5	17.0	2.00	3.5
			80/67	31.7	26.3	41.2	3.09	10.2							
			85/71	34.1	27.2	43.9	3.15	10.8							
	7.5	3.5 (8.0)	75/63	31.3	26.0	40.2	2.90	10.8							
			80/67	34.0	26.9	43.1	2.94	11.5							
			85/71	36.6	27.9	45.9	2.97	12.3							
	11	7.1 (16.3)	75/63	32.1	26.1	40.8	2.85	11.2							
			80/67	34.8	27.2	43.7	2.88	12.1							
			85/71	37.6	28.2	46.6	2.90	12.9							
110	4	1.1 (2.5)	75/63	27.0	24.1	36.7	3.18	8.5							
			80/67	29.1	25.2	39.1	3.26	8.9							
			85/71	31.4	26.0	41.7	3.34	9.4							
	7.5	3.4 (7.8)	75/63	28.7	24.7	38.1	3.08	9.3							
			80/67	31.1	25.8	40.8	3.14	9.9							
			85/71	33.6	27.1	43.4	3.18	10.5							
	11	6.9 (15.9)	75/63	29.3	24.9	38.6	3.04	9.6							
			80/67	31.8	26.1	41.3	3.09	10.3							
			85/71	34.4	27.3	44.1	3.12	11.0							

Extended Range - Anti-freeze required
 AHRI/ISO13256-1 certified performance is rated at entering air conditions of 80.6°F DB and 66.2°F WB in cooling and 68°F DB in heating.
 Tabulated unit performance does not include fan or pump power corrections required for AHRI/ISO standard performance ratings.
 Unit performance may be interpolated. Extrapolation is not allowed.
 For conditions other than rating conditions provided, consult the BST selection software.
 Ratings below 40°F are with a methanol solution.
 The results reported herein are estimates based on testing by FHP. Variations in the installation and operational environment may alter performance. Bosch disclaims all warranties, express and implied, that the performance will be as reported, including the warranty of merchantability and fitness for purpose. In addition, continuous research and development may result in a change to an appliances design and specifications, which Bosch may change without notice. Before purchase, confirm the design specifications of the appliance.



Capacity Data

LV041 (1150 CFM)

Cooling									Heating							
Entering Fluid Temp (°F)	Water Flow (GPM)	Pressure Drop PSI (FOH)	Entering Air Temp (db/wb) °F	Total Capacity (MBTUH)	Sensible Capacity (MBTUH)	Heat of Rejection (MBTUH)	Power Input (kW)	EER	Entering Fluid Temp (°F)	Entering Air Temp (°F)	Total Capacity (MBTUH)	Heat of Absorption (MBTUH)	Power Input (kW)	COP		
50	5	2.1 (4.8)	75/63	44.8	32.0	52.9	2.52	17.8	30	60	27.1	19.3	2.44	3.3		
			80/67	48.1	33.0	56.3	2.53	19.0		70	25.9	17.6	2.54	3.0		
			85/71	51.4	33.9	59.7	2.54	20.2		80	24.6	16.0	2.62	2.8		
	9	6.1 (14.0)	75/63	47.2	33.0	54.8	2.33	20.3		60	29.0	20.9	2.52	3.4		
			80/67	50.7	34.1	58.3	2.32	21.9		70	27.6	19.2	2.62	3.1		
			85/71	54.5	35.0	62.0	2.30	23.7		80	26.1	17.4	2.71	2.8		
	13	11.9 (27.4)	75/63	48.2	33.5	55.5	2.25	21.4		60	29.9	21.7	2.55	3.4		
			80/67	51.8	34.5	59.2	2.23	23.2		70	28.4	19.8	2.66	3.1		
			85/71	55.7	35.5	63.0	2.20	25.3		80	26.8	18.0	2.75	2.9		
	60	5	2.1 (4.8)	75/63	42.5	31.0	51.2	2.71		15.7	40	60	31.4	23.0	2.61	3.5
				80/67	45.6	32.0	54.4	2.73		16.7		70	30.1	21.3	2.74	3.2
				85/71	48.9	32.9	57.8	2.75		17.8		80	28.8	19.6	2.85	3.0
9		5.9 (13.6)	75/63	44.8	32.0	52.9	2.52	17.7	60	33.8		25.1	2.70	3.7		
			80/67	48.2	33.0	56.4	2.52	19.1	70	32.4		23.2	2.83	3.4		
			85/71	51.8	34.0	60.0	2.51	20.6	80	30.8		21.3	2.95	3.1		
13		11.5 (26.5)	75/63	45.7	32.4	53.6	2.45	18.7	60	35.0		26.1	2.74	3.7		
			80/67	49.3	33.5	57.2	2.44	20.2	70	33.5		24.1	2.87	3.4		
			85/71	53.0	34.5	60.9	2.41	22.0	80	31.7		21.9	3.00	3.1		
70		5	2 (4.6)	75/63	40.1	29.9	49.3	2.91	13.8	50		60	36.2	27.1	2.78	3.8
				80/67	43.1	31.0	52.5	2.94	14.6			70	34.9	25.4	2.92	3.5
				85/71	46.2	31.9	55.7	2.97	15.6			80	33.7	23.4	3.07	3.2
	9	5.7 (13.1)	75/63	42.3	30.8	51.0	2.73	15.5	60		39.2	29.8	2.87	4.0		
			80/67	45.6	31.9	54.4	2.74	16.6	70		37.6	27.9	3.02	3.6		
			85/71	49.0	32.9	57.8	2.74	17.9	80		36.2	25.7	3.17	3.4		
	13	11.1 (25.6)	75/63	43.2	31.2	51.7	2.66	16.2	60		40.5	31.1	2.91	4.1		
			80/67	46.6	32.3	55.1	2.66	17.5	70		38.8	29.0	3.07	3.7		
			85/71	50.1	33.4	58.7	2.65	18.9	80		37.3	26.7	3.21	3.4		
	80	5	1.9 (4.3)	75/63	37.6	28.8	47.4	3.11	12.1		60	60	41.2	31.7	2.93	4.1
				80/67	40.5	29.9	50.5	3.15	12.8			70	39.9	29.8	3.10	3.8
				85/71	43.5	30.8	53.6	3.19	13.6			80	38.5	27.8	3.26	3.5
9		5.6 (12.9)	75/63	39.7	29.7	49.0	2.95	13.5	60	44.8		34.9	3.03	4.3		
			80/67	42.8	30.8	52.3	2.97	14.4	70	43.1		32.6	3.21	3.9		
			85/71	46.1	31.8	55.7	2.98	15.5	80	42.0		29.9	3.38	3.6		
13		10.8 (24.9)	75/63	40.5	30.0	49.6	2.88	14.0	60	46.4		36.4	3.06	4.4		
			80/67	43.8	31.2	53.0	2.89	15.1	70	44.5		33.9	3.25	4.0		
			85/71	47.2	32.2	56.5	2.89	16.3	80	43.3		30.9	3.42	3.7		
85		5	1.9 (4.3)	75/63	36.3	28.2	46.4	3.21	11.3	70		60	46.5	36.5	3.07	4.4
				80/67	39.2	29.3	49.5	3.26	12.0			70	45.0	34.3	3.26	4.0
				85/71	42.1	30.2	52.6	3.30	12.8			80	43.5	32.1	3.45	3.7
	9	5.5 (12.6)	75/63	38.3	29.1	48.0	3.06	12.5	60		50.5	40.2	3.16	4.7		
			80/67	41.4	30.2	51.2	3.08	13.4	70		48.7	37.6	3.36	4.2		
			85/71	44.6	31.2	54.5	3.10	14.4	80		46.8	35.1	3.56	3.9		
	13	10.6 (24.4)	75/63	39.1	29.4	48.6	2.99	13.1	60		52.3	41.9	3.19	4.8		
			80/67	42.3	30.5	51.9	3.01	14.0	70		50.3	39.1	3.40	4.3		
			85/71	45.7	31.6	55.3	3.02	15.1	80		48.2	36.3	3.60	3.9		
	90	5	1.9 (4.3)	75/63	35.0	27.7	45.4	3.31	10.6		80	60	51.8	41.4	3.18	4.8
				80/67	37.8	28.9	48.3	3.36	11.2			70	50.2	39.0	3.40	4.3
				85/71	40.5	29.9	51.4	3.41	11.9			80	48.5	36.6	3.61	3.9
9		5.4 (12.4)	75/63	37.0	28.5	46.9	3.16	11.7	60	56.2		45.6	3.26	5.1		
			80/67	40.0	29.6	50.1	3.20	12.5	70	54.2		42.8	3.49	4.6		
			85/71	43.0	30.8	53.3	3.22	13.4	80	52.1		39.9	3.71	4.1		
13		10.4 (23.9)	75/63	37.7	28.8	47.5	3.11	12.1	60	58.2		47.5	3.28	5.2		
			80/67	40.9	29.9	50.8	3.13	13.1	70	56.0		44.4	3.52	4.7		
			85/71	44.0	31.1	54.1	3.14	14.0	80	53.7		41.3	3.75	4.2		
100		5	1.8 (4.1)	75/63	32.3	26.7	43.2	3.50	9.2	Extended Range - Anti-freeze required						
				80/67	35.0	27.6	46.2	3.57	9.8							
				85/71	37.6	28.7	49.1	3.63	10.4							
	9	5.2 (11.9)	75/63	34.1	27.2	44.7	3.38	10.1								
			80/67	37.0	28.4	47.8	3.42	10.8								
			85/71	39.9	29.7	50.8	3.46	11.5								
	13	10.1 (23.2)	75/63	34.8	27.5	45.2	3.33	10.5								
			80/67	37.7	28.9	48.3	3.36	11.2								
			85/71	40.9	29.8	51.6	3.39	12.0								
	110	5	1.8 (4.1)	75/63	29.6	25.3	41.0	3.69	8.0							
				80/67	32.0	26.7	43.8	3.76	8.5							
				85/71	34.5	27.8	46.6	3.84	9.0							
9		5.1 (11.7)	75/63	31.2	26.0	42.3	3.58	8.7								
			80/67	33.9	27.2	45.3	3.64	9.3								
			85/71	36.6	28.5	48.3	3.70	9.9								
13		9.8 (22.6)	75/63	31.8	26.5	42.8	3.54	9.0								
			80/67	34.6	27.5	45.9	3.60	9.6								
			85/71	37.4	28.8	48.9	3.64	10.3								

Extended Range - Anti-freeze required
 AHRI/ISO13256-1 certified performance is rated at entering air conditions of 80.6°F DB and 66.2°F WB in cooling and 68°F DB in heating.
 Tabulated unit performance does not include fan or pump power corrections required for AHRI/ISO standard performance ratings.
 Unit performance may be interpolated. Extrapolation is not allowed.
 For conditions other than rating conditions provided, consult the BST selection software.
 Ratings below 40°F are with a methanol solution.
 The results reported herein are estimates based on testing by FHP. Variations in the installation and operational environment may alter performance. Bosch disclaims all warranties, express and implied, that the performance will be as reported, including the warranty of merchantability and fitness for purpose. In addition, continuous research and development may result in a change to an appliances design and specifications, which Bosch may change without notice. Before purchase, confirm the design specifications of the appliance.



Capacity Data

LV042 (1500 CFM)

Cooling									Heating					
Entering Fluid Temp (°F)	Water Flow (GPM)	Pressure Drop PSI (FOH)	Entering Air Temp (db/wb) °F	Total Capacity (MBTUH)	Sensible Capacity (MBTUH)	Heat of Rejection (MBTUH)	Power Input (kW)	EER	Entering Fluid Temp (°F)	Entering Air Temp (°F)	Total Capacity (MBTUH)	Heat of Absorption (MBTUH)	Power Input (kW)	COP
50	5	2.1 (4.8)	75/63	45.2	33.0	53.8	2.72	16.6						
			80/67	48.6	34.1	57.3	2.73	17.8						
			85/71	52.0	35.1	60.8	2.73	19.0						
	10	7.4 (17.0)	75/63	48.1	34.2	56.2	2.49	19.3						
			80/67	51.7	35.4	59.9	2.48	20.9						
			85/71	55.6	36.2	63.9	2.45	22.7						
	13	11.8 (27.0)	75/63	48.8	34.6	56.8	2.44	20.0						
			80/67	52.5	35.7	60.6	2.41	21.7						
			85/71	56.5	36.6	64.6	2.38	23.7						
60	5	2 (4.6)	75/63	42.9	32.0	51.8	2.91	14.7						
			80/67	46.1	33.1	55.2	2.93	15.7						
			85/71	49.4	34.1	58.7	2.94	16.8						
	10	7.1 (16.3)	75/63	45.6	33.1	54.1	2.69	16.9						
			80/67	49.2	34.1	57.8	2.68	18.3						
			85/71	52.8	35.3	61.6	2.67	19.8						
	13	11.4 (26.2)	75/63	46.2	33.4	54.7	2.64	17.5						
			80/67	49.9	34.4	58.5	2.62	19.0						
			85/71	53.7	35.6	62.3	2.60	20.7						
70	5	2 (4.6)	75/63	40.4	30.9	49.8	3.10	13.0						
			80/67	43.5	31.9	53.1	3.13	13.9						
			85/71	46.7	32.9	56.6	3.16	14.8						
	10	6.9 (15.9)	75/63	43.0	31.9	52.0	2.90	14.8						
			80/67	46.4	33.1	55.5	2.90	16.0						
			85/71	50.0	34.1	59.2	2.90	17.3						
	13	11.1 (25.6)	75/63	43.6	32.2	52.5	2.85	15.3						
			80/67	47.1	33.4	56.1	2.85	16.5						
			85/71	50.8	34.4	59.9	2.83	17.9						
80	5	1.9 (4.3)	75/63	37.9	29.7	47.7	3.30	11.5						
			80/67	40.9	30.8	51.0	3.35	12.2						
			85/71	43.8	32.0	54.1	3.38	13.0						
	10	6.7 (15.4)	75/63	40.3	30.7	49.7	3.12	12.9						
			80/67	43.6	31.8	53.2	3.13	13.9						
			85/71	47.0	33.0	56.8	3.14	15.0						
	13	10.7 (24.7)	75/63	40.9	31.0	50.2	3.07	13.3						
			80/67	44.3	32.1	53.8	3.08	14.4						
			85/71	47.7	33.3	57.4	3.07	15.5						
85	5	1.9 (4.3)	75/63	36.6	29.1	46.6	3.40	10.7						
			80/67	39.4	30.5	49.7	3.45	11.4						
			85/71	42.4	31.3	53.0	3.49	12.1						
	10	6.6 (15.2)	75/63	38.9	30.1	48.6	3.23	12.0						
			80/67	42.0	31.4	51.9	3.25	12.9						
			85/71	45.3	32.6	55.4	3.26	13.9						
	13	10.5 (24.2)	75/63	39.5	30.3	49.1	3.18	12.4						
			80/67	42.7	31.7	52.5	3.20	13.4						
			85/71	46.1	32.8	56.0	3.20	14.4						
90	5	1.9 (4.3)	75/63	35.1	28.7	45.4	3.50	10.0						
			80/67	38.0	29.9	48.5	3.55	10.7						
			85/71	40.9	30.8	51.8	3.60	11.4						
	10	6.5 (14.9)	75/63	37.5	29.4	47.4	3.34	11.2						
			80/67	40.6	30.7	50.8	3.36	12.1						
			85/71	43.8	31.8	54.2	3.38	13.0						
	13	10.4 (23.9)	75/63	38.0	29.7	47.9	3.30	11.5						
			80/67	41.2	30.9	51.3	3.32	12.4						
			85/71	44.5	32.1	54.8	3.33	13.4						
100	5	1.8 (4.1)	75/63	32.5	27.5	43.1	3.69	8.8						
			80/67	35.1	28.8	46.1	3.76	9.3						
			85/71	37.9	29.7	49.2	3.82	9.9						
	10	6.3 (14.5)	75/63	34.5	28.4	44.9	3.55	9.7						
			80/67	37.5	29.7	48.1	3.59	10.4						
			85/71	40.6	30.7	51.5	3.63	11.2						
	13	10.1 (23.2)	75/63	35.0	28.6	45.3	3.51	10.0						
			80/67	38.0	29.9	48.6	3.55	10.7						
			85/71	41.2	30.9	52.0	3.58	11.5						
110	5	1.8 (4.1)	75/63	29.7	26.2	40.7	3.88	7.7						
			80/67	32.2	27.4	43.6	3.96	8.1						
			85/71	34.7	28.6	46.6	4.03	8.6						
	10	6.1 (14.0)	75/63	31.5	27.2	42.3	3.76	8.4						
			80/67	34.3	28.5	45.4	3.82	9.0						
			85/71	37.1	29.7	48.6	3.86	9.6						
	13	9.8 (22.6)	75/63	32.0	27.3	42.7	3.73	8.6						
			80/67	34.8	28.7	45.8	3.78	9.2						
			85/71	37.8	29.7	49.1	3.82	9.9						

Extended Range - Anti-freeze required
 AHR/ISO13256-1 certified performance is rated at entering air conditions of 80.6°F DB and 66.2°F WB in cooling and 68°F DB in heating.
 Tabulated unit performance does not include fan or pump power corrections required for AHR/ISO standard performance ratings.
 Unit performance may be interpolated. Extrapolation is not allowed.
 For conditions other than rating conditions provided, consult the BST selection software.
 Ratings below 40°F are with a methanol solution.
 The results reported herein are estimates based on testing by FHP. Variations in the installation and operational environment may alter performance. Bosch disclaims all warranties, express and implied, that the performance will be as reported, including the warranty of merchantability and fitness for purpose. In addition, continuous research and development may result in a change to an appliances design and specifications, which Bosch may change without notice. Before purchase, confirm the design specifications of the appliance.



Capacity Data

LV048 (1600 CFM)

Cooling									Heating					
Entering Fluid Temp (°F)	Water Flow (GPM)	Pressure Drop PSI (FOH)	Entering Air Temp (db/wb) °F	Total Capacity (MBTUH)	Sensible Capacity (MBTUH)	Heat of Rejection (MBTUH)	Power Input (kW)	EER	Entering Fluid Temp (°F)	Entering Air Temp (°F)	Total Capacity (MBTUH)	Heat of Absorption (MBTUH)	Power Input (kW)	COP
50	6	0.9 (2.0)	75/63	52.8	38.0	62.5	2.95	17.9	30	60	34.3	25.4	2.69	3.7
			80/67	56.3	39.1	66.0	2.97	19.0		70	32.0	22.6	2.79	3.4
			85/71	59.9	40.1	69.8	2.99	20.1		80	29.8	19.6	2.89	3.0
	12	3 (6.9)	75/63	56.5	39.7	65.2	2.63	21.5		60	36.9	27.5	2.81	3.8
			80/67	60.3	40.7	68.9	2.61	23.1		70	34.4	24.9	2.92	3.4
			85/71	64.3	41.6	72.9	2.58	24.9		80	32.0	21.9	3.02	3.1
	16	5.1 (11.7)	75/63	57.5	40.1	65.9	2.54	22.7		60	37.7	28.2	2.85	3.9
			80/67	61.4	41.1	69.8	2.51	24.5		70	35.2	25.5	2.96	3.5
			85/71	65.5	42.1	73.8	2.46	26.6		80	32.6	22.6	3.06	3.1
60	6	0.8 (1.8)	75/63	49.9	36.8	60.3	3.19	15.6	40	60	38.5	28.9	2.88	3.9
			80/67	53.3	37.9	63.8	3.23	16.5		70	36.5	26.5	3.02	3.5
			85/71	56.9	39.0	67.5	3.26	17.5		80	34.4	23.5	3.14	3.2
	12	2.9 (6.6)	75/63	53.4	38.3	62.9	2.91	18.4		60	41.8	31.8	3.01	4.1
			80/67	57.1	39.3	66.6	2.90	19.7		70	39.6	29.3	3.16	3.7
			85/71	61.0	40.4	70.6	2.89	21.1		80	37.3	26.5	3.29	3.3
	16	4.9 (11.3)	75/63	54.3	38.6	63.6	2.83	19.2		60	42.9	32.7	3.05	4.1
			80/67	58.1	39.7	67.4	2.81	20.7		70	40.6	30.2	3.20	3.7
			85/71	62.1	40.8	71.4	2.79	22.3		80	38.2	27.2	3.33	3.4
70	6	0.8 (1.8)	75/63	46.9	35.5	57.9	3.43	13.7	50	60	43.5	33.3	3.07	4.1
			80/67	50.3	36.6	61.6	3.48	14.5		70	41.5	30.7	3.23	3.8
			85/71	53.8	37.7	65.2	3.52	15.3		80	39.3	28.3	3.38	3.4
	12	2.8 (6.4)	75/63	50.2	36.8	60.5	3.18	15.8		60	47.4	36.5	3.21	4.3
			80/67	53.8	38.0	64.2	3.19	16.9		70	45.3	33.7	3.37	3.9
			85/71	57.6	39.1	68.1	3.19	18.0		80	43.2	31.0	3.54	3.6
	16	4.7 (10.8)	75/63	51.0	37.1	61.1	3.11	16.4		60	48.7	37.5	3.24	4.4
			80/67	54.7	38.3	64.9	3.11	17.6		70	46.6	35.5	3.42	4.0
			85/71	58.7	39.5	68.9	3.10	18.9		80	44.3	32.3	3.59	3.6
80	6	0.8 (1.8)	75/63	43.9	34.1	55.6	3.67	12.0	60	60	48.8	37.8	3.25	4.4
			80/67	47.2	35.2	59.2	3.73	12.7		70	47.0	35.3	3.43	4.0
			85/71	50.5	36.7	62.7	3.78	13.4		80	45.3	32.8	3.62	3.7
	12	2.7 (6.2)	75/63	46.8	35.3	57.9	3.44	13.6		60	53.7	42.2	3.39	4.6
			80/67	50.4	36.5	61.7	3.47	14.5		70	51.6	39.2	3.59	4.2
			85/71	54.2	37.7	65.6	3.49	15.5		80	49.5	37.0	3.79	3.8
	16	4.6 (10.6)	75/63	47.6	35.6	58.5	3.38	14.1		60	55.2	44.0	3.43	4.7
			80/67	51.3	36.9	62.3	3.40	15.1		70	53.0	41.1	3.64	4.3
			85/71	55.1	38.0	66.3	3.41	16.2		80	50.8	38.3	3.84	3.9
85	6	0.8 (1.8)	75/63	42.3	33.3	54.4	3.78	11.2	70	60	54.6	43.2	3.41	4.7
			80/67	45.5	34.9	57.8	3.85	11.8		70	52.8	40.7	3.63	4.3
			85/71	48.9	35.7	61.6	3.92	12.5		80	51.0	38.1	3.84	3.9
	12	2.7 (6.2)	75/63	45.2	34.5	56.6	3.57	12.7		60	60.3	48.3	3.56	5.0
			80/67	48.7	35.8	60.4	3.61	13.5		70	58.2	45.2	3.79	4.5
			85/71	52.3	37.2	64.2	3.64	14.4		80	56.0	42.8	4.02	4.1
	16	4.5 (10.3)	75/63	45.9	34.9	57.2	3.51	13.1		60	62.1	50.4	3.60	5.1
			80/67	49.5	36.1	61.0	3.54	14.0		70	59.8	47.3	3.84	4.6
			85/71	53.3	37.5	64.9	3.56	15.0		80	57.5	44.3	4.07	4.1
90	6	0.8 (1.8)	75/63	40.7	32.9	53.1	3.90	10.5	80	60	60.7	48.9	3.57	5.0
			80/67	44.0	33.9	56.7	3.98	11.1		70	58.9	46.2	3.81	4.5
			85/71	47.3	35.2	60.3	4.05	11.7		80	57.0	43.5	4.06	4.1
	12	2.6 (5.9)	75/63	43.5	33.7	55.3	3.70	11.8		60	67.3	54.7	3.70	5.3
			80/67	46.9	35.3	59.0	3.75	12.5		70	65.0	51.4	3.97	4.8
			85/71	50.6	36.3	62.9	3.79	13.4		80	62.8	48.1	4.23	4.4
	16	4.4 (10.1)	75/63	44.2	34.1	55.9	3.65	12.1		60	70.0	56.7	3.74	5.5
			80/67	47.7	35.6	59.6	3.68	13.0		70	66.8	53.8	4.02	4.9
			85/71	51.5	36.7	63.5	3.72	13.9		80	64.3	50.5	4.28	4.4
100	6	0.7 (1.6)	75/63	37.5	31.5	50.6	4.12	9.1	Extended Range - Anti-freeze required					
			80/67	40.6	32.9	54.1	4.22	9.6		AHRI/ISO13256-1 certified performance is rated at entering air conditions of 80.6°F DB and 66.2°F WB in cooling and 68°F DB in heating.				
			85/71	43.7	34.2	57.6	4.31	10.2		Tabulated unit performance does not include fan or pump power corrections required for AHRI/ISO standard performance ratings.				
	12	2.6 (5.9)	75/63	40.0	32.3	52.6	3.95	10.1		Unit performance may be interpolated. Extrapolation is not allowed.				
			80/67	43.3	33.9	56.2	4.02	10.8		For conditions other than rating conditions provided, consult the BST selection software.				
			85/71	46.9	35.0	60.0	4.08	11.5		Ratings below 40°F are with a methanol solution.				
	16	4.3 (9.9)	75/63	40.6	32.6	53.1	3.91	10.4		The results reported herein are estimates based on testing by FHP. Variations in the installation and operational environment may alter performance. Bosch disclaims all warranties, express and implied, that the performance will be as reported, including the warranty of merchantability and fitness for purpose. In addition, continuous research and development may result in a change to an appliances design and specifications, which Bosch may change without notice. Before purchase, confirm the design specifications of the appliance.				
			80/67	44.0	34.2	56.7	3.96	11.1						
			85/71	47.7	35.3	60.7	4.02	11.9						
110	6	0.7 (1.6)	75/63	34.4	30.2	48.2	4.35	7.9						
			80/67	37.2	31.7	51.4	4.46	8.3						
			85/71	40.2	33.0	54.8	4.57	8.8						
	12	2.5 (5.7)	75/63	36.5	30.9	49.8	4.20	8.7						
			80/67	39.6	32.5	53.3	4.29	9.2						
			85/71	43.0	34.0	57.0	4.36	9.9						
	16	4.2 (9.6)	75/63	37.0	31.1	50.2	4.17	8.9						
			80/67	40.3	32.5	53.9	4.25	9.5						
			85/71	43.7	34.3	57.5	4.31	10.2						

Extended Range - Anti-freeze required

AHRI/ISO13256-1 certified performance is rated at entering air conditions of 80.6°F DB and 66.2°F WB in cooling and 68°F DB in heating.

Tabulated unit performance does not include fan or pump power corrections required for AHRI/ISO standard performance ratings.

Unit performance may be interpolated. Extrapolation is not allowed.

For conditions other than rating conditions provided, consult the BST selection software.

Ratings below 40°F are with a methanol solution.

The results reported herein are estimates based on testing by FHP. Variations in the installation and operational environment may alter performance. Bosch disclaims all warranties, express and implied, that the performance will be as reported, including the warranty of merchantability and fitness for purpose. In addition, continuous research and development may result in a change to an appliances design and specifications, which Bosch may change without notice. Before purchase, confirm the design specifications of the appliance.



Capacity Data

LV060 (2000 CFM)

Cooling									Heating								
Entering Fluid Temp (°F)	Water Flow (GPM)	Pressure Drop PSI (FOH)	Entering Air Temp (db/wb) °F	Total Capacity (MBTUH)	Sensible Capacity (MBTUH)	Heat of Rejection (MBTUH)	Power Input (kW)	EER	Entering Fluid Temp (°F)	Entering Air Temp (°F)	Total Capacity (MBTUH)	Heat of Absorption (MBTUH)	Power Input (kW)	COP			
50	8	1.7 (3.9)	75/63	65.6	47.0	77.2	3.52	18.7	30	60	45.2	30.8	3.98	3.3			
			80/67	70.0	48.3	81.8	3.56	19.7		70	45.7	27.9	4.35	3.1			
			85/71	74.5	49.6	86.6	3.62	20.6		80	44.4	27.0	4.77	2.7			
	13	4 (9.2)	75/63	67.6	47.9	78.5	3.28	20.6		60	47.4	32.6	4.03	3.4			
			80/67	72.2	49.2	83.3	3.31	21.8		70	47.4	30.0	4.40	3.2			
			85/71	77.1	50.5	88.3	3.35	23.1		80	46.9	27.9	4.81	2.9			
	20	8.6 (19.8)	75/63	68.7	48.4	79.2	3.14	21.9		60	48.8	33.7	4.06	3.5			
			80/67	73.5	49.8	84.1	3.16	23.2		70	48.2	31.4	4.43	3.2			
			85/71	78.6	51.1	89.3	3.19	24.7		80	46.6	30.2	4.84	2.8			
	60	8	1.6 (3.6)	75/63	63.0	45.9	75.6	3.83		16.5	40	60	49.7	35.9	4.10	3.6	
				80/67	67.2	47.2	80.1	3.88		17.3		70	51.5	33.0	4.48	3.4	
				85/71	71.7	48.5	84.7	3.93		18.2		80	49.9	32.0	4.91	3.0	
13		3.8 (8.7)	75/63	64.9	46.7	76.8	3.59	18.1	60	53.7		38.3	4.16	3.8			
			80/67	69.4	48.1	81.5	3.62	19.2	70	52.9		36.2	4.54	3.4			
			85/71	74.2	49.3	86.4	3.66	20.3	80	53.0		33.4	4.96	3.1			
20		8.3 (19.1)	75/63	66.0	47.2	77.5	3.46	19.1	60	54.8		41.0	4.20	3.8			
			80/67	70.7	48.6	82.3	3.48	20.3	70	54.6		37.5	4.57	3.5			
			85/71	75.6	49.9	87.3	3.51	21.6	80	53.9		35.2	5.00	3.2			
70		8	1.5 (3.4)	75/63	60.2	44.7	74.0	4.17	14.4	50		60	57.4	41.8	4.23	4.0	
				80/67	64.4	46.1	78.3	4.22	15.3			70	55.7	40.0	4.62	3.5	
				85/71	68.7	47.2	82.9	4.28	16.1			80	55.1	37.8	5.06	3.2	
	13	3.7 (8.5)	75/63	62.1	45.5	75.1	3.93	15.8	60		60.7	44.8	4.30	4.1			
			80/67	66.5	46.8	79.7	3.96	16.8	70		59.8	42.4	4.69	3.7			
			85/71	71.1	48.1	84.4	4.00	17.8	80		58.9	39.9	5.13	3.4			
	20	8.1 (18.6)	75/63	63.2	46.0	75.8	3.80	16.6	60		62.9	46.6	4.34	4.2			
			80/67	67.7	47.3	80.4	3.82	17.7	70		61.8	44.0	4.74	3.8			
			85/71	72.5	48.6	85.3	3.85	18.8	80		60.8	41.2	5.18	3.4			
	80	8	1.5 (3.4)	75/63	57.4	43.5	72.4	4.56	12.6		60	60	64.2	48.2	4.37	4.3	
				80/67	61.5	44.8	76.6	4.61	13.4			70	63.4	45.8	4.78	3.9	
				85/71	65.6	45.9	81.0	4.66	14.1			80	61.6	43.8	5.23	3.5	
13		3.6 (8.3)	75/63	59.3	44.2	73.4	4.31	13.8	60	68.3		51.7	4.46	4.5			
			80/67	63.5	45.6	77.8	4.34	14.6	70	67.1		49.0	4.87	4.0			
			85/71	67.9	46.8	82.4	4.38	15.5	80	66.1		46.3	5.32	3.6			
20		7.8 (17.9)	75/63	60.2	44.6	74.0	4.17	14.4	60	70.2		55.1	4.53	4.5			
			80/67	64.6	46.0	78.5	4.20	15.4	70	68.5		51.4	4.93	4.1			
			85/71	69.2	47.3	83.2	4.22	16.4	80	68.3		48.1	5.38	3.7			
85		8	1.5 (3.4)	75/63	56.0	42.7	71.7	4.77	11.8	70		60	72.7	54.2	4.54	4.7	
				80/67	60.0	44.1	75.8	4.82	12.5			70	71.7	51.6	4.95	4.2	
				85/71	64.0	45.5	80.0	4.87	13.1			80	69.5	49.6	5.42	3.8	
	13	3.5 (8.0)	75/63	57.8	43.5	72.6	4.51	12.8	60		76.2	59.0	4.65	4.8			
			80/67	62.0	44.9	76.9	4.55	13.6	70		74.8	56.0	5.07	4.3			
			85/71	66.3	46.1	81.5	4.58	14.5	80		73.5	53.0	5.53	3.9			
	20	7.7 (17.7)	75/63	58.7	43.9	73.1	4.38	13.4	60		79.3	61.6	4.73	4.9			
			80/67	63.0	45.4	77.6	4.40	14.3	70		76.6	58.8	5.15	4.4			
			85/71	67.5	46.6	82.2	4.43	15.3	80		75.0	55.4	5.61	3.9			
	90	8	1.5 (3.4)	75/63	54.6	42.1	70.9	4.99	10.9		80	60	79.2	61.9	4.73	4.9	
				80/67	58.5	43.4	75.0	5.04	11.6			70	79.1	58.3	5.15	4.5	
				85/71	62.4	44.7	79.2	5.10	12.2			80	76.7	56.0	5.63	4.0	
13		3.5 (8.0)	75/63	56.3	42.8	71.8	4.73	11.9	60	84.5		66.6	4.87	5.1			
			80/67	60.4	44.2	76.1	4.76	12.7	70	82.8		63.2	5.30	4.6			
			85/71	64.5	45.8	80.3	4.80	13.5	80	81.3		59.9	5.77	4.1			
20		7.6 (17.5)	75/63	57.2	43.2	72.3	4.60	12.4	60	88.0		69.5	4.97	5.2			
			80/67	61.4	44.7	76.6	4.62	13.3	70	85.0		66.4	5.39	4.6			
			85/71	65.7	46.2	81.1	4.64	14.2	80	83.0		62.6	5.86	4.1			
100		8	1.4 (3.2)	75/63	51.7	40.7	69.6	5.49	9.4	Extended Range - Anti-freeze required							
				80/67	55.3	42.2	73.5	5.54	10.0			AHRI/ISO13256-1 certified performance is rated at entering air conditions of 80.6°F DB and 66.2°F WB in cooling and 68°F DB in heating.					
				85/71	59.1	43.5	77.4	5.59	10.6			Tabulated unit performance does not include fan or pump power corrections required for AHRI/ISO standard performance ratings.					
	13	3.4 (7.8)	75/63	53.2	41.4	70.3	5.22	10.2	Unit performance may be interpolated. Extrapolation is not allowed.								
			80/67	57.1	42.9	74.4	5.25	10.9	For conditions other than rating conditions provided, consult the BST selection software.								
			85/71	61.2	44.2	78.5	5.28	11.6	Ratings below 40°F are with a methanol solution.								
	20	7.3 (16.8)	75/63	54.1	41.8	70.7	5.08	10.6	The results reported herein are estimates based on testing by FHP. Variations in the installation and operational environment may alter performance. Bosch disclaims all warranties, express and implied, that the performance will be as reported, including the warranty of merchantability and fitness for purpose. In addition, continuous research and development may result in a change to an appliances design and specifications, which Bosch may change without notice. Before purchase, confirm the design specifications of the appliance.								
			80/67	58.0	43.5	74.7	5.10	11.4									
			85/71	62.2	44.9	79.0	5.12	12.2									
	110	8	1.4 (3.2)	75/63	48.5	39.4	68.4	6.08	8.0								
				80/67	52.0	40.9	72.1	6.12	8.5								
				85/71	55.6	42.3	75.8	6.17	9.0								
13		3.3 (7.6)	75/63	50.0	40.0	68.9	5.79	8.6									
			80/67	53.6	41.8	72.7	5.81	9.2									
			85/71	57.4	43.3	76.6	5.84	9.8									
20		7.1 (16.3)	75/63	50.7	40.5	69.1	5.65	9.0									
			80/67	54.5	42.2	73.0	5.65	9.6									
			85/71	58.4	43.7	77.1	5.67	10.3									

Extended Range - Anti-freeze required

AHRI/ISO13256-1 certified performance is rated at entering air conditions of 80.6°F DB and 66.2°F WB in cooling and 68°F DB in heating.

Tabulated unit performance does not include fan or pump power corrections required for AHRI/ISO standard performance ratings.

Unit performance may be interpolated. Extrapolation is not allowed.

For conditions other than rating conditions provided, consult the BST selection software.

Ratings below 40°F are with a methanol solution.

The results reported herein are estimates based on testing by FHP. Variations in the installation and operational environment may alter performance. Bosch disclaims all warranties, express and implied, that the performance will be as reported, including the warranty of merchantability and fitness for purpose. In addition, continuous research and development may result in a change to an appliances design and specifications, which Bosch may change without notice. Before purchase, confirm the design specifications of the appliance.



Capacity Data

LV070 (2200 CFM)

Cooling									Heating																									
Entering Fluid Temp (°F)	Water Flow (GPM)	Pressure Drop PSI (FOH)	Entering Air Temp (db/wb) °F	Total Capacity (MBTUH)	Sensible Capacity (MBTUH)	Heat of Rejection (MBTUH)	Power Input (kW)	EER	Entering Fluid Temp (°F)	Entering Air Temp (°F)	Total Capacity (MBTUH)	Heat of Absorption (MBTUH)	Power Input (kW)	COP																				
50	10	2.6 (5.9)	75/63	72.2	53.9	85.4	3.96	18.3	30	60	49.4	35.1	4.19	3.5																				
			80/67	77.1	55.5	90.5	4.01	19.3		70	49.4	32.6	4.56	3.2																				
			85/71	82.2	57.0	95.9	4.06	20.2		80	48.8	30.5	4.97	2.9																				
	15	5.4 (12.4)	75/63	74.0	54.7	86.6	3.76	19.7		60	51.3	36.8	4.23	3.6																				
			80/67	79.2	56.3	91.9	3.80	20.9		70	50.2	34.6	4.59	3.2																				
			85/71	84.5	57.9	97.4	3.84	22.0		80	49.4	32.4	5.00	2.9																				
	20	9.1 (20.9)	75/63	74.9	55.1	87.2	3.66	20.5		60	52.1	37.7	4.24	3.6																				
			80/67	80.2	56.7	92.6	3.69	21.8		70	51.1	35.5	4.60	3.3																				
			85/71	85.7	58.3	98.2	3.72	23.0		80	50.0	32.9	5.01	2.9																				
	60	10	2.5 (5.7)	75/63	69.2	52.5	83.5	4.29		16.1	40	60	55.7	41.0	4.30	3.8																		
				80/67	74.0	54.2	88.4	4.34		17.1		70	55.6	38.3	4.66	3.5																		
				85/71	78.9	55.8	93.6	4.39		18.0		80	54.9	36.1	5.08	3.2																		
15		5.2 (11.9)	75/63	71.0	53.3	84.6	4.09	17.3	60	57.9		43.2	4.33	3.9																				
			80/67	75.9	55.0	89.7	4.13	18.4	70	56.8		40.9	4.70	3.5																				
			85/71	81.0	56.9	95.0	4.17	19.4	80	55.9		38.5	5.12	3.2																				
20		8.7 (20.0)	75/63	71.8	53.7	85.2	4.00	18.0	60	59.2		44.5	4.35	4.0																				
			80/67	76.9	55.4	90.4	4.03	19.1	70	58.0		42.0	4.72	3.6																				
			85/71	82.1	57.3	95.7	4.06	20.2	80	56.9		39.3	5.14	3.2																				
70		10	2.4 (5.5)	75/63	66.1	51.2	81.5	4.65	14.2	50		60	62.6	47.7	4.40	4.2																		
				80/67	70.6	52.9	86.2	4.70	15.0			70	61.6	45.6	4.78	3.8																		
				85/71	75.4	54.5	91.2	4.76	15.9			80	60.8	42.9	5.21	3.4																		
	15	5 (11.5)	75/63	67.7	51.9	82.5	4.45	15.2	60		65.5	50.5	4.45	4.3																				
			80/67	72.4	53.9	87.4	4.49	16.1	70		64.2	47.8	4.83	3.9																				
			85/71	77.5	55.3	92.7	4.53	17.1	80		63.1	45.2	5.26	3.5																				
	20	8.5 (19.6)	75/63	68.5	52.5	82.9	4.35	15.7	60		67.1	52.0	4.47	4.4																				
			80/67	73.4	54.3	88.0	4.38	16.8	70		65.7	49.2	4.86	4.0																				
			85/71	78.5	56.0	93.3	4.42	17.8	80		64.4	46.4	5.28	3.6																				
	80	10	2.4 (5.5)	75/63	62.8	49.8	79.5	5.05	12.4		60	60	71.1	54.5	4.53	4.6																		
				80/67	67.2	51.6	84.1	5.10	13.2			70	69.1	52.7	4.92	4.1																		
				85/71	71.6	53.6	88.7	5.15	13.9			80	67.6	49.5	5.35	3.7																		
15		4.9 (11.3)	75/63	64.3	50.7	80.3	4.85	13.3	60	73.7		58.3	4.59	4.7																				
			80/67	68.9	52.6	85.1	4.88	14.1	70	72.2		55.3	4.98	4.2																				
			85/71	73.6	54.3	90.0	4.92	15.0	80	70.8		52.4	5.42	3.8																				
20		8.2 (18.9)	75/63	65.1	51.1	80.8	4.75	13.7	60	75.8		60.2	4.62	4.8																				
			80/67	69.8	52.9	85.7	4.78	14.6	70	73.6		57.0	5.01	4.3																				
			85/71	74.7	54.7	90.7	4.81	15.5	80	72.4		53.8	5.45	3.9																				
85		10	2.3 (5.3)	75/63	61.0	49.4	78.4	5.27	11.6	70		60	79.3	62.2	4.67	5.0																		
				80/67	65.3	51.2	82.9	5.32	12.3			70	76.8	59.5	5.07	4.4																		
				85/71	69.7	52.9	87.5	5.37	13.0			80	75.4	56.4	5.52	4.0																		
	15	4.8 (11.0)	75/63	62.7	49.8	79.4	5.07	12.4	60		82.7	66.6	4.75	5.1																				
			80/67	67.2	51.6	84.1	5.10	13.2	70		80.4	63.4	5.15	4.6																				
			85/71	71.7	53.6	88.8	5.14	14.0	80		80.0	59.0	5.60	4.2																				
	20	8.1 (18.6)	75/63	63.5	50.1	79.9	4.97	12.8	60		84.8	68.7	4.79	5.2																				
			80/67	68.1	51.9	84.6	5.00	13.6	70		82.8	64.6	5.20	4.7																				
			85/71	72.7	54.0	89.4	5.02	14.5	80		80.4	61.7	5.64	4.2																				
	90	10	2.3 (5.3)	75/63	59.5	48.4	77.6	5.51	10.8		80	60	87.9	70.2	4.84	5.3																		
				80/67	63.5	50.5	81.9	5.55	11.4			70	85.0	67.3	5.25	4.7																		
				85/71	68.0	51.9	86.6	5.61	12.1			80	83.8	64.1	5.71	4.3																		
15		4.7 (10.8)	75/63	60.8	49.3	78.3	5.29	11.5	60	92.0		75.2	4.94	5.5																				
			80/67	65.4	50.9	83.0	5.33	12.3	70	89.2		71.7	5.35	4.9																				
			85/71	69.8	52.9	87.6	5.37	13.0	80	88.5		66.8	5.81	4.5																				
20		7.9 (18.2)	75/63	61.6	49.6	78.7	5.19	11.9	60	94.3		77.6	4.99	5.5																				
			80/67	66.1	51.5	83.4	5.22	12.7	70	91.9		73.9	5.41	5.0																				
			85/71	70.9	52.9	88.3	5.26	13.5	80	89.2		69.8	5.86	4.5																				
100		10	2.2 (5.0)	75/63	55.9	47.4	75.7	6.02	9.3	Extended Range - Anti-freeze required																								
				80/67	59.9	49.2	79.9	6.07	9.9																									
				85/71	64.1	50.6	84.3	6.13	10.5																									
	15	4.6 (10.6)	75/63	57.3	47.8	76.4	5.81	9.9	AHRI/ISO13256-1 certified performance is rated at entering air conditions of 80.6°F DB and 66.2°F WB in cooling and 68°F DB in heating. Tabulated unit performance does not include fan or pump power corrections required for AHRI/ISO standard performance ratings. Unit performance may be interpolated. Extrapolation is not allowed. For conditions other than rating conditions provided, consult the BST selection software. Ratings below 40°F are with a methanol solution. The results reported herein are estimates based on testing by FHP. Variations in the installation and operational environment may alter performance. Bosch disclaims all warranties, express and implied, that the performance will be as reported, including the warranty of merchantability and fitness for purpose. In addition, continuous research and development may result in a change to an appliances design and specifications, which Bosch may change without notice. Before purchase, confirm the design specifications of the appliance.																									
			80/67	61.5	49.8	80.7	5.84	10.5																										
			85/71	65.8	51.5	85.2	5.87	11.2																										
	20	7.7 (17.7)	75/63	57.9	48.1	76.7	5.71	10.2														AHRI	CERTIFIED											
			80/67	62.2	50.3	81.1	5.72	10.9																										
			85/71	66.8	51.5	85.9	5.76	11.6																										
	110	10	2.1 (4.8)	75/63	52.3	45.8	74.1	6.64																				7.9	C	UL	US			
				80/67	56.0	47.8	78.0	6.68																				8.4						
				85/71	59.9	49.5	82.1	6.73																				8.9						
15		4.5 (10.3)	75/63	53.7	46.1	74.8	6.41	8.4		Intertek																								
			80/67	57.7	48.0	78.9	6.43	9.0																										
			85/71	61.6	50.3	82.9	6.46	9.5																										
20		7.5 (17.2)	75/63	54.2	46.7	74.9	6.30	8.6	www.ahricertified.org																									
			80/67	58.3	48.5	79.1	6.32	9.2																										
			85/71	62.5	50.3	83.4	6.34	9.9																										

Unit Electrical Data

with Standard Blower Motor

Model	Voltage Code	Voltage/Hz/ Phase	Voltage Min/Max	Compressor			Blower Motor			Min. Circuit Amps	HACR Breaker
				Quantity	RLA	LRA	FLA	HP	Total Unit FLA		
LV007	1	208-230/1/60	197/253	1	2.6	17.7	0.96	0.1	3.6	4.2	15
	2	265/1/60	238/292	1	2.6	13.5	0.96	0.1	3.6	4.2	15
LV009	1	208-230/1/60	197/253	1	3.4	22.2	0.96	0.1	4.4	5.2	15
	2	265/1/60	238/292	1	2.9	18.8	0.85	0.1	3.8	4.5	15
LV012	0	115/1/60	103/126	1	9.6	58.4	2.2	0.1	11.8	14.2	20
	1	208-230/1/60	197/253	1	4.6	28.0	0.96	0.1	5.6	6.7	15
	2	265/1/60	238/292	1	3.8	22.2	0.85	0.1	4.7	5.6	15
LV015	1	208-230/1/60	197/253	1	5.6	29.0	1.10	0.17	6.7	8.1	15
	2	265/1/60	238/292	1	4.6	20.0	0.90	0.17	5.5	6.7	15
LV018	1	208-230/1/60	197/253	1	6.5	43.0	1.8	0.25	8.3	9.9	15
	2	265/1/60	238/292	1	5.8	46.0	1.6	0.25	7.4	8.9	15
LV024	1	208-230/1/60	197/253	1	7.4	43.0	1.8	0.25	9.2	11.1	15
	2	265/1/60	238/292	1	6.7	46.0	1.6	0.25	8.3	10.0	15
	3	208-230/3/60	197/253	1	5.9	63.0	1.8	0.25	7.7	9.2	15
	4	460/3/60	414/506	1	2.9	30.0	0.9	0.25	3.8	4.5	15
LV030	1	208-230/1/60	197/253	1	9.9	54.0	1.8	0.25	11.7	14.2	20
	2	265/1/60	238/292	1	8.5	46.0	1.6	0.25	10.1	12.2	20
	3	208-230/3/60	197/253	1	6.9	63.0	1.8	0.25	8.7	10.4	15
	4	460/3/60	414/506	1	5.4	30.0	0.9	0.25	6.3	7.7	15
LV036	1	208-230/1/60	197/253	1	13	74.0	4.4	0.5	17.4	20.7	30
	2	265/1/60	238/292	1	11.3	67.0	3.3	0.5	14.6	17.4	25
	3	208-230/3/60	197/253	1	7.8	68.0	4.4	0.5	12.2	14.2	20
	4	460/3/60	414/506	1	3.9	34.0	1.8	0.5	5.7	6.7	15
LV041	1	208-230/1/60	197/253	1	13.6	88.0	4.4	0.75	18.0	21.4	35
	3	208-230/3/60	197/253	1	8.8	68.0	4.4	0.75	13.2	15.4	20
	4	460/3/60	414/506	1	4.4	34.0	2.8	0.75	7.2	8.3	15
LV042	1	208-230/1/60	197/253	1	13.6	88.0	4.4	0.5	18.0	21.4	35
	3	208-230/3/60	197/253	1	8.8	68.0	4.4	0.5	13.2	15.4	20
	4	460/3/60	414/506	1	4.4	34.0	1.8	0.5	6.2	7.3	15
LV048	1	208-230/1/60	197/253	1	15.7	84.0	4.4	0.75	20.1	24.0	35
	3	208-230/3/60	197/253	1	11	88.0	4.4	0.75	15.4	18.2	25
	4	460/3/60	414/506	1	5.4	44.0	2.8	0.75	8.2	9.6	15
	5	575/3/60	517/633	1	4.4	36.0	2.6	0.75	7.0	8.1	15
LV070	1	208-230/1/60	197/253	1	28.3	178.0	5.5	0.75	33.8	40.9	60
	3	208-230/3/60	197/253	1	19.2	136.0	5.5	0.75	24.7	29.5	45
	4	460/3/60	414/506	1	8.7	66.1	2.8	0.75	11.5	13.7	20
	5	575/3/60	517/633	1	6.9	55.3	2.6	0.75	9.5	11.2	15

208/230V units shipped with transformer wired for 230V—for 208V remove orange transformer primary lead and replace with red lead. All blower motors are single phase.

UNIT POWER SUPPLY: A voltage variation of +/- 10% of nameplate rating is acceptable. Phase imbalance shall not exceed 2%.

Unit Electrical Data

with ECM Constant Torque

Model	Voltage Code	Voltage/Hz/ Phase	Voltage Min/Max	Compressor			Blower Motor			Min. Circuit Amps	HACR Breaker
				Quantity	RLA	LRA	FLA	HP	Total Unit FLA		
LV015	1	208-230/1/60	197/253	1	5.6	29.0	2.80	0.33	8.4	9.8	15
	2	265/1/60	238/292	1	4.6	20.0	2.60	0.33	7.2	8.4	15
LV018	1	208-230/1/60	197/253	1	6.5	43.0	2.8	0.33	9.3	10.9	15
	2	265/1/60	238/292	1	5.8	46.0	2.6	0.33	8.4	9.9	15
LV024	1	208-230/1/60	197/253	1	7.4	43.0	2.8	0.33	10.2	12.1	15
	2	265/1/60	238/292	1	6.7	46.0	2.6	0.33	9.3	11.0	15
	3	208-230/3/60	197/253	1	5.9	63.0	2.8	0.33	8.7	10.2	15
	4	460/3/60	414/506	1	2.9	30.0	2.1	0.50	5.0	5.7	15
LV030	1	208-230/1/60	197/253	1	9.9	54.0	2.8	0.33	12.7	15.2	25
	2	265/1/60	238/292	1	8.5	46.0	2.6	0.33	11.1	13.2	20
	3	208-230/3/60	197/253	1	6.9	63.0	2.8	0.33	9.7	11.4	15
	4	460/3/60	414/506	1	5.4	30.0	2.1	0.50	7.5	8.9	15
LV036	1	208-230/1/60	197/253	1	13	74.0	4.1	0.5	17.1	20.4	30
	2	265/1/60	238/292	1	11.3	67.0	3.9	0.5	15.2	18.0	25
	3	208-230/3/60	197/253	1	7.8	68.0	4.1	0.5	11.9	13.9	20
	4	460/3/60	414/506	1	3.9	34.0	2.1	0.5	6.0	7.0	15
LV041	1	208-230/1/60	197/253	1	13.6	88.0	6.0	0.75	19.6	23.0	35
	3	208-230/3/60	197/253	1	8.8	68.0	6.0	0.75	14.8	17.0	25
	4	460/3/60	414/506	1	4.4	34.0	4.6	0.75	9.0	10.1	15
LV042	1	208-230/1/60	197/253	1	13.6	88.0	6.0	0.75	19.6	23.0	35
	3	208-230/3/60	197/253	1	8.8	68.0	6.0	0.75	14.8	17.0	25
	4	460/3/60	414/506	1	4.4	34.0	4.6	0.75	9.0	10.1	15
LV048	1	208-230/1/60	197/253	1	15.7	84.0	6.0	0.75	21.7	25.6	40
	3	208-230/3/60	197/253	1	11	88.0	6.0	0.75	17.0	19.8	30
	4	460/3/60	414/506	1	5.4	44.0	4.6	0.75	10.0	11.4	15
LV060	1	208-230/1/60	197/253	1	26.3	145.0	7.6	1.00	33.9	40.5	60
	3	208-230/3/60	197/253	1	15.6	123.0	7.6	1.00	23.2	27.1	40
	4	460/3/60	414/506	1	7.8	70.0	4.0	1.00	11.8	13.8	20
LV070	1	208-230/1/60	197/253	1	28.3	158.0	7.6	1.00	35.9	43.0	70
	3	208-230/3/60	197/253	1	19.2	155.0	7.6	1.00	26.8	31.6	50
	4	460/3/60	414/506	1	8.7	75.0	4.0	1.00	12.7	14.9	20

Unit Electrical Data

with ECM Constant Airflow (Variable Speed)

Model	Voltage Code	Voltage/Hz/ Phase	Voltage Min/Max	Compressor			Blower Motor			Min. Circuit Amps	HACR Breaker
				Quantity	RLA	LRA	FLA	HP	Total Unit FLA		
LV015	1	208-230/1/60	197/253	1	5.6	29.0	2.80	0.33	8.4	9.8	15
	2	265/1/60	238/292	1	4.6	20.0	2.60	0.33	7.2	8.4	15
LV018	1	208-230/1/60	197/253	1	6.5	43.0	2.8	0.33	9.3	10.9	15
	2	265/1/60	238/292	1	5.8	46.0	2.6	0.33	8.4	9.9	15
LV024	1	208-230/1/60	197/253	1	7.4	43.0	2.8	0.33	10.2	12.1	15
	2	265/1/60	238/292	1	6.7	46.0	2.6	0.33	9.3	11.0	15
	3	208-230/3/60	197/253	1	5.9	63.0	2.8	0.33	8.7	10.2	15
	4	460/3*/60	414/506	1	2.9	30.0	2.6	0.33	5.5	6.2	15
LV030	1	208-230/1/60	197/253	1	9.9	54.0	2.8	0.33	12.7	15.2	25
	2	265/1/60	238/292	1	8.5	46.0	2.6	0.33	11.1	13.2	20
	3	208-230/3/60	197/253	1	6.9	63.0	2.8	0.33	9.7	11.4	15
	4	460/3*/60	414/506	1	5.4	30.0	2.6	0.33	8.0	9.4	15
LV036	1	208-230/1/60	197/253	1	13	74.0	4.3	0.50	17.3	20.6	30
	2	265/1/60	238/292	1	11.3	67.0	4.1	0.50	15.4	18.2	25
	3	208-230/3/60	197/253	1	7.8	68.0	4.3	0.50	12.1	14.1	20
	4	460/3*/60	414/506	1	3.9	34.0	4.1	0.50	8.0	9.0	15
LV041	1	208-230/1/60	197/253	1	13.6	88.0	6.8	0.75	20.4	23.8	35
	3	208-230/3/60	197/253	1	8.8	68.0	6.8	0.75	15.6	17.8	25
	4	460/3*/60	414/506	1	4.4	34.0	5.5	0.75	9.9	11.0	15
LV042	1	208-230/1/60	197/253	1	13.6	88.0	6.8	0.75	20.4	23.8	35
	3	208-230/3/60	197/253	1	8.8	68.0	6.8	0.75	15.6	17.8	25
	4	460/3*/60	414/506	1	4.4	34.0	5.5	0.75	9.9	11.0	15
LV048	1	208-230/1/60	197/253	1	15.7	84.0	6.8	0.75	22.5	26.4	40
	3	208-230/3/60	197/253	1	11	88.0	6.8	0.75	17.8	20.6	30
	4	460/3*/60	414/506	1	5.4	44.0	5.5	0.75	10.9	12.3	15
LV060	1	208-230/1/60	197/253	1	26.3	145.0	9.1	1.00	35.4	42.0	60
	3	208-230/3/60	197/253	1	15.6	123.0	9.1	1.00	24.7	28.6	40
	4	460/3*/60	414/506	1	7.8	70.0	6.9	1.00	14.7	16.7	20
LV070	1	208-230/1/60	197/253	1	28.3	158.0	9.1	1.00	37.4	44.5	70
	3	208-230/3/60	197/253	1	19.2	155.0	9.1	1.00	28.3	33.1	50
	4	460/3*/60	414/506	1	8.7	75.0	6.9	1.00	15.6	17.8	25

* 460V models with a constant airflow motor require a neutral wire to provide 265V power to the motor

Blower Performance CFM

Standard PSC Blower Motor

Model	Available External Static Pressure (in. wc. wet coil and filter included)													
	Motor Speed	Rated Airflow	0.10	0.20	0.30	0.40	0.50	0.60	0.70	0.80	0.90	1.00	1.10	1.20
LV007	Low		370	340	295	250	-	-	-	-	-	-	-	-
	Medium	300	390	360	330	300	260	-	-	-	-	-	-	-
	High		410	380	350	315	280	210	-	-	-	-	-	-
LV009	Low		370	340	295	250	-	-	-	-	-	-	-	-
	Medium		390	360	330	300	260	-	-	-	-	-	-	-
	High	350	410	380	350	315	280	210	-	-	-	-	-	-
LV012	Low		300	290	290	300	-	-	-	-	-	-	-	-
	Medium		380	380	360	330	290	-	-	-	-	-	-	-
	High	400	420	400	380	360	340	320	-	-	-	-	-	-
LV015	Low		500	450	400	-	-	-	-	-	-	-	-	-
	Medium		560	520	480	430	400			-	-	-	-	-
	High	500	700	650	600	550	500	450	400	-	-	-	-	-
LV018	Low		630	590	560	-	-	-	-	-	-	-	-	-
	Medium	650	810	790	760	730	680	590	-	-	-	-	-	-
	High		1010	970	920	870	800	680	530	-	-	-	-	-
LV024	Low		650	610	570	540	510	-	-	-	-	-	-	-
	Medium		830	820	800	770	720	620	-	-	-	-	-	-
	High	850	1050	1000	950	910	840	710	570	-	-	-	-	-
LV030	Low		740	730	700	660	610	-	-	-	-	-	-	-
	Medium		830	810	770	730	680	620	-	-	-	-	-	-
	High	950	1000	950	900	830	750	690	630	-	-	-	-	-
LV036	Low		1290	1250	1200	1150	1080	1000	-	-	-	-	-	-
	Medium		1410	1350	1290	1220	1150	1060	900	-	-	-	-	-
	High	1200	1500	1440	1370	1290	1210	1120	1000	900	-	-	-	-
LV041	Low		950	900	840	780	720	700	-	-	-	-	-	-
	Medium		1200	1140	1080	1010	930	870	820	-	-	-	-	-
	High	1300	1490	1400	1320	1240	1160	1080	990	910	-	-	-	-
LV042	Low		1210	1210	1190	1160	1120	1080	-	-	-	-	-	-
	Medium		1460	1450	1430	1390	1330	1250	1160	-	-	-	-	-
	High	1400	1750	1710	1670	1620	1560	1460	1330	1210	1080	-	-	-
LV048	Low		1450	1440	1420	1400	1360	1320	-	-	-	-	-	-
	Medium		1700	1670	1630	1580	1530	1470	1400	-	-	-	-	-
	High	1600	1930	1870	1810	1740	1670	1600	1520	1430	1340	-	-	-
LV070	Low		1570	1560	1550	1540	1530	1505	1475	1440	1400	-	-	-
	Medium		1900	1890	1880	1870	1860	1825	1790	1730	1670	1590	1500	-
	High	2100	2240	2220	2200	2150	2100	2050	2000	1940	1870	1800	1700	1590

Blower Performance CFM

ECM Constant Torque

Model	Available External Static Pressure (in. wc. wet coil and filter included)													
	Tap #	Rated Airflow	0.10	0.20	0.30	0.40	0.50	0.60	0.70	0.80	0.90	1.00	1.10	1.20
LV015	1		480	440	410	370	340	-	-	-	-	-	-	-
	2		530	490	450	420	380	340	-	-	-	-	-	-
	3	500	600	560	510	470	440	410	370	-	-	-	-	-
	4		650	600	560	520	500	480	440	380	-	-	-	-
	5		710	660	620	580	550	520	490	470	-	-	-	-
LV018	1		630	590	560	530	490	-	-	-	-	-	-	-
	2	650	720	700	670	630	600	560	-	-	-	-	-	-
	3		790	770	750	710	670	620	560	-	-	-	-	-
	4		910	890	850	810	740	670	590	520	-	-	-	-
	5		1010	970	920	860	810	750	660	530	-	-	-	-
LV024	1		650	610	580	560	520	-	-	-	-	-	-	-
	2		740	720	690	660	620	570	-	-	-	-	-	-
	3		850	830	800	770	730	690	630	-	-	-	-	-
	4	850	950	920	890	870	840	820	770	650	-	-	-	-
	5		1160	1110	1050	990	920	800	670	560	-	-	-	-
LV030	1		620	600	570	540	490	-	-	-	-	-	-	-
	2		730	710	670	640	610	550	-	-	-	-	-	-
	3		820	790	760	740	710	670	630	-	-	-	-	-
	4		940	910	880	850	800	740	660	-	-	-	-	-
	5	950	1070	1010	950	900	840	760	670	-	-	-	-	-
LV036	1		1120	1090	1055	1030	1000	-	-	-	-	-	-	-
	2		1260	1230	1200	1170	1140	1080	-	-	-	-	-	-
	3	1200	1330	1290	1250	1210	1170	1100	1030	-	-	-	-	-
	4		1400	1360	1310	1250	1190	1120	1040	960	-	-	-	-
	5		1470	1420	1360	1290	1220	1140	1050	970	890	-	-	-
LV041	1		840	770	700	620	-	-	-	-	-	-	-	-
	2		1220	1150	1080	1010	950	-	-	-	-	-	-	-
	3		1430	1360	1280	1200	1130	1080	-	-	-	-	-	-
	4	1300	1540	1460	1380	1300	1220	1140	1060	-	-	-	-	-
	5		1620	1550	1470	1370	1260	1180	1090	1000	-	-	-	-
LV042	1		1270	1250	1230	1210	-	-	-	-	-	-	-	-
	2	1400	1440	1420	1410	1410	1400	1380	1340	-	-	-	-	-
	3		1540	1530	1510	1500	1490	1470	1430	1350	-	-	-	-
	4		1650	1630	1610	1600	1580	1530	1460	1360	1240	-	-	-
	5		1730	1720	1700	1670	1620	1570	1490	1380	1260	1100	-	-
LV048	1		1390	1370	1350	1320	-	-	-	-	-	-	-	-
	2		1600	1580	1550	1530	1510	-	-	-	-	-	-	-
	3	1600	1730	1700	1670	1650	1630	1600	1580	1540	-	-	-	-
	4		1830	1810	1780	1760	1740	1710	1670	1600	1520	-	-	-
	5		1930	1910	1880	1860	1830	1780	1720	1640	1540	1420	-	-
LV060	1		1900	1880	1860	1820	-	-	-	-	-	-	-	-
	2		2000	1970	1950	1920	1890	1860	-	-	-	-	-	-
	3	2000	2110	2090	2060	2030	2010	1970	1940	1910	1880	-	-	-
	4		2220	2200	2170	2140	2110	2080	2050	2060	2050	2000	1920	-
	5		2340	2320	2290	2260	2230	2210	2180	2150	2110	2070	2000	1930
LV070	1		2050	2010	1970	1930	-	-	-	-	-	-	-	-
	2		2150	2120	2080	2030	1990	1960	-	-	-	-	-	-
	3	2100	2270	2230	2200	2160	2120	2080	2040	2010	1980	-	-	-
	4		2390	2350	2320	2280	2250	2200	2160	2130	2100	2070	2030	-
	5		2520	2480	2450	2420	2380	2330	2290	2260	2220	2170	2100	2020

Blower Performance CFM

ECM Constant Airflow (Variable Speed)

Model	Available External Static Pressure (in. wc. wet coil and filter included)													
	Fan Speed	Rated Airflow	0.10	0.20	0.30	0.40	0.50	0.60	0.70	0.80	0.90	1.00	1.10	1.20
LV015	A - Low		450	450	450	450	450	450	450	440	440	430	-	-
	A - Normal	500	500	500	500	500	500	500	500	480	470	460	-	-
	A - Hi		580	580	580	580	580	580	580	570	560	550	-	-
LV018	B - Low		550	540	540	540	540	540	540	530	520	500	-	-
	B - Normal	650	650	650	650	650	650	650	640	630	610	590	-	-
	B - Hi		750	750	750	750	750	750	740	730	710	690	-	-
LV024	C - Low		720	720	720	720	720	720	720	700	650	560	-	-
	C - Normal	850	850	850	850	850	850	850	850	850	800	700	-	-
	C - Hi		960	960	960	960	960	960	960	960	880	790	-	-
LV030	D - Low		810	810	810	810	810	810	810	770	720	650	-	-
	D - Normal	950	950	950	950	950	950	950	950	900	850	780	-	-
	D - Hi		980	980	980	980	980	980	980	950	900	820	-	-
LV036	A - Low		1020	1020	1020	1020	1020	1020	1000	990	960	930	-	-
	A - Normal	1200	1200	1200	1200	1200	1200	1200	1180	1160	1130	1090	-	-
	A - Hi		1380	1380	1380	1380	1380	1380	1360	1330	1300	1250	-	-
LV041	A - Low		1100	1100	1100	1100	1100	1090	1070	1050	1020	990	-	-
	A - Normal	1300	1280	1280	1280	1280	1280	1260	1240	1220	1180	1140	-	-
	A - Hi		1300	1300	1300	1300	1300	1280	1260	1240	1200	1160	-	-
LV042	B - Low		1190	1190	1190	1190	1190	1190	1190	1190	1190	1190	1190	-
	B - Normal	1400	1400	1400	1400	1400	1400	1400	1400	1400	1400	1400	1400	-
	B - Hi		1630	1630	1630	1630	1630	1630	1630	1630	1630	1630	1630	-
LV048	A - Low		1340	1340	1340	1340	1340	1340	1340	1340	1340	1340	1340	-
	A - Normal	1600	1600	1600	1600	1600	1600	1600	1600	1600	1600	1600	1600	-
	A - Hi		1810	1810	1810	1810	1810	1810	1810	1810	1810	1810	1810	-
LV060	A - Low		1700	1700	1700	1700	1700	1700	1700	1700	1700	1690	1690	1680
	A - Normal	2000	2000	2000	2000	2000	2000	2000	2000	2000	2000	1980	1980	1980
	A - Hi		2220	2220	2220	2220	2220	2220	2220	2220	2220	2130	2100	2070
LV070	B - Low		1870	1870	1870	1870	1870	1870	1870	1870	1870	1870	1870	1870
	B - Normal	2200	2200	2200	2200	2200	2200	2200	2200	2200	2200	2200	2200	2200
	B - Hi		2330	2330	2330	2330	2330	2330	2330	2330	2330	2330	2330	2330

Physical Data

	LV Models	LV007	LV009	LV012	LV015	LV018	LV024	LV030
	Compressor Type (Qty. 1)	Rotary	Rotary	Rotary	Rotary	Reciprocating	Reciprocating	Reciprocating
PSC Fan Motor & Blower	Max. Water Working Pressure (PSIG/kPa)	400	400	400	400	400	400	400
	Fan Motor Type/Speeds	PSC/3	PSC/3	PSC/3	PSC/3	PSC/3	PSC/3	PSC/3
	Fan Motor (HP)	1/10	1/10	1/10	1/6	1/4	1/4	1/4
	Blower Wheel Size (Dia. x W)	4.5 x 4.5	4.5 x 4.5	5.5 x 4.5	9 x 7	9 x 7	9 x 7	9 x 7
ECM Fan Motor & Blower	Fan Motor Type/Speeds	N/A	N/A	N/A	X13 / EON	X13 / EON	X13 / EON	X13 / EON
	Fan Motor (HP)	N/A	N/A	N/A	1/3	1/3	1/3* / 1/2	1/3* / 1/2
	Blower Wheel Size (Dia. x W)	N/A	N/A	N/A	9 x 7	9 x 7	9 x 7	9 x 7
Water Connection Size	FPT	3/4	3/4	3/4	3/4	3/4	3/4	3/4
	Coaxial Coil Volume (gal)	0.04	0.06	0.08	0.09	0.14	0.14	0.24
	Condensate Connection in. FPT	3/4	3/4	3/4	3/4	3/4	3/4	3/4
Vertical Cabinet	Refrigeration Charge (oz)	14	15	21	19	28	29	37
	Air Coil Dimensions (H x W)	10 x 14	10 x 14	10 x 14	12 x 16.5	16 x 16.5	20 x 16.5	20 x 16.5
	Std. Filter - 1" Throwaway (L x H)	10 x 16	10 x 16	10 x 16	16 x 20	16 x 20	20 x 20	20 x 20
	Opt. Filter - 2" MERV-8 or -13 Throwaway (L x H)	10 x 16	10 x 16	10 x 16	16 x 20	16 x 20	20 x 20	20 x 20
	Weight - Operating (lbs)**	98	103	105	123	173	177	190
	Weight - Shipping (lbs)**	126	130	132	151	201	205	217
Horizontal Cabinet	Refrigeration Charge (oz)	17	19	19	19	29	29	39
	Air Coil Dimensions (H x W)	10 x 14	10 x 14	10 x 14	12 x 16.5	16 x 16.5	16 x 20.5	16 x 20.5
	Std. Filter - 1" Throwaway (L x H)	10 x 16	10 x 16	10 x 16	16 x 20	16 x 20	16 x 25	16 x 25
	Opt. Filter - 2" MERV-8 or -13 Throwaway (L x H)	10 x 16	10 x 16	10 x 16	16 x 20	16 x 20	16 x 25	16 x 25
	Weight - Operating (lbs)**	96	100	105	136	174	181	190
	Weight - Shipping (lbs)**	128	132	134	158	208	212	224

	LV Models	LV036	LV041	LV042	LV048	LV060	LV070
	Compressor Type (Qty. 1)	Reciprocating	Reciprocating	Reciprocating	Reciprocating	Scroll	Scroll
	Max Water Working Pressure (PSIG/kPa)	400	400	400	400	400	400
PSC Fan Motor & Blower	Fan Motor Type/Speeds	PSC/3	PSC/3	PSC/3	PSC/3	N/A	PSC/3
	Fan Motor (HP)	1/2	1/2	1/2	3/4	N/A	3/4+
	Blower Wheel Size (Dia. x W)	9x7	10x8	10x8	10x8	N/A	11x9
ECM Fan Motor & Blower	Fan Motor Type/Speeds	X13 / EON	X13 / EON	X13 / EON	X13 / EON	X13 / EON	X13 / EON
	Fan Motor (HP)	1/2	1/2	3/4	3/4	1	1
	Blower Wheel Size (Dia. x W)	9x7	10x8	10x8	10x8	11x9	11x9
Water Connection Size	FPT	3/4	3/4	3/4	1	1	1
	Coaxial Coil Volume (gal)	0.27	0.27	0.27	0.49	0.62	0.62
	Condensate Connection in. FPT	3/4	3/4	3/4	3/4	3/4	3/4
Vertical Cabinet	Refrigeration Charge (oz)	48	48	48	52	59	73
	Air Coil Dimensions (H x W)	24x20.2	20x16	24x20.2	24x26.75	24x26.75	32x26.2
	Std. Filter - 1" Throwaway (L x H)	24x24	20x20	24x24	24x30	24x30	16x30 @2
	Opt. Filter - 2" MERV-8 or -13 Throwaway (L x H)	24x24	20x20	24x24	24x30	24x30	16x30 @2
	Weight - Operating (lbs)**	229	217	239	287	307	336
	Weight - Shipping (lbs)**	255	243	265	312	331	360
Horizontal Cabinet	Refrigeration Charge (oz)	46	N/A	43	44	64	61
	Air Coil Dimensions (H x W)	18x27.5	N/A	18x27.5	20x32	20x32	20x42
	Std. Filter - 1" Throwaway (L x H)	18x30	N/A	18x30	20x34.5	20x34.5	20x24 @2
	Opt. Filter - 2" MERV-8 or -13 Throwaway (L x H)	18x30	N/A	18x30	20x34.5	20x34.5	20x24 @2
	Weight - Operating (lbs)**	226	N/A	231	274	288	316
	Weight - Shipping (lbs)**	270	N/A	264	299	318	365

* Unit sizes 024 & 030 with -4 voltage (460/3/60), the X13 motor will be 1/2 HP rather than 1/3 HP.

** This data reflects standard unit weights only. Additional options may cause differences in listed weights.

Horizontal Cabinet Corner Weights

Configuration			Left Hand Evaporator				Right Hand Evaporator			
Model	Total		Left Front*	Right Front*	Left Back	Right Back	Left Front*	Right Front*	Left Back	Right Back
LVH 007	Lbs	98	28	21	25	24	21	28	24	25
	kg	45	13	10	11	11	10	13	11	11
LVH 009	Lbs	103	29	23	26	25	23	29	25	26
	kg	47	13	10	12	11	10	13	11	12
LVH 012	Lbs	105	29	24	26	26	24	29	26	26
	kg	48	13	11	12	12	11	13	12	12
LVH 015	Lbs	127	36	28	34	29	28	36	29	34
	kg	58	16	13	15	13	13	16	13	15
LVH 018	Lbs	177	57	36	48	37	36	57	37	48
	kg	80	26	16	22	17	16	26	17	22
LVH 024	Lbs	181	58	37	48	38	37	58	38	48
	kg	82	26	17	22	17	17	26	17	22
LVH 030	Lbs	194	61	41	52	41	41	61	41	52
	kg	88	28	18	23	19	18	28	19	23
LVH 036	Lbs	237	71	49	66	52	49	71	52	66
	kg	108	32	22	30	24	22	32	24	30
LVH 042	Lbs	231	70	47	64	50	47	70	50	64
	kg	105	32	21	29	23	21	32	23	29
LVH 048	Lbs	268	87	60	62	60	60	87	60	62
	kg	122	39	27	28	27	27	39	27	28
LVH 060	Lbs	288	88	65	69	66	65	88	66	69
	kg	131	40	29	31	30	29	40	30	31
LVH 072	Lbs	316	98	72	76	70	72	98	70	76
	kg	143	44	32	35	32	32	44	32	35

NOTE: * Front is control box end.



Vertical Unit Dimensions

Overall unit dimensions do not include filter rack or duct flanges.

Model	A	B	C	D	E	F	G	H	J	K	M	N	P	Q	Condenser Water Connections	Recommended Replacement Nominal Filter Size
	Width	Depth	Height	Discharge Depth	Discharge Width	Cabinet Edge to Discharge	Left Side to Discharge	Water Inlet	Water Outlet	Condensate Drain	R/A Duct Width	R/A Duct Flange Height	Filter Rack Height			
LV007	19.0	19.0	24.25	10.0	8.0	4.5	9.3	2.44	9.68	13.87	16.0	8.0	10.0	5.4	3/4"FPT	10 × 16 × 1
LV009	19.0	19.0	24.25	10.0	8.0	4.5	9.3	2.44	9.68	13.87	16.0	8.0	10.0	5.4	3/4"FPT	10 × 16 × 1
LV012	19.0	19.0	24.25	10.0	8.0	4.5	9.3	2.44	9.68	13.87	16.0	8.0	10.0	5.4	3/4"FPT	10 × 16 × 1
LV015	21.5	21.5	32.25	14.0	14.0	3.1	5.2	2.85	8.45	15.87	20.0	14.0	16.0	5.2	3/4"FPT	16 × 20 × 1
LV018	21.5	21.5	32.25	14.0	14.0	3.1	5.2	2.85	8.45	15.87	20.0	14.0	16.0	5.2	3/4"FPT	16 × 20 × 1
LV024	21.5	21.5	39.25	14.0	14.0	3.1	5.2	2.80	8.45	18.87	20.0	18.0	20.0	5.2	3/4"FPT	20 × 20 × 1
LV030	21.5	21.5	39.25	14.0	14.0	3.1	5.2	2.80	8.45	18.87	20.0	18.0	20.0	5.2	3/4"FPT	20 × 20 × 1
LV036	21.5	26.0	43.25	16.0	14.0	4.0	5.0	2.75	10.77	18.87	24.0	22.0	24.0	5.0	3/4"FPT	24 × 24 × 1
LV041	21.5	21.5	39.25	16.0	14.0	1.7	4.7	2.80	8.45	18.87	20.0	18.0	20.0	4.7	3/4"FPT	20 × 20 × 1
LV042	21.5	26.0	43.25	16.0	14.0	4.0	5.0	2.75	10.77	18.87	24.0	22.0	24.0	5.0	3/4"FPT	24 × 24 × 1
LV048	24.0	32.5	45.25	18.0	14.0	7.0	6.2	3.26	13.20	20.87	30.0	22.0	24.0	6.2	1"FPT	24 × 30 × 1
LV060	24.0	32.5	45.25	18.0	14.0	7.0	6.2	3.26	13.20	20.87	30.0	22.0	24.0	6.2	1"FPT	24 × 30 × 1
LV070	26.0	33.25	58.25	18.0	16.0	7.8	7.2	2.92	13.36	25.87	30.0	30.0	32.0	7.2	1"FPT	16 × 30 × 1 (2)

All dimensions within +- 0.125". All condensate drain connections are 3/4" FPT. LV015-070 can be field converted between end blow and straight through supply air configurations. Specifications subject to change without notice.

1" filter rack extends 1.23" beyond the side of the unit. 2" filter rack extends 2.89" beyond the side of the unit. The 2" filter rack is 4 sided with a filter access door on one end and can accept either a 1" or 2" filter.

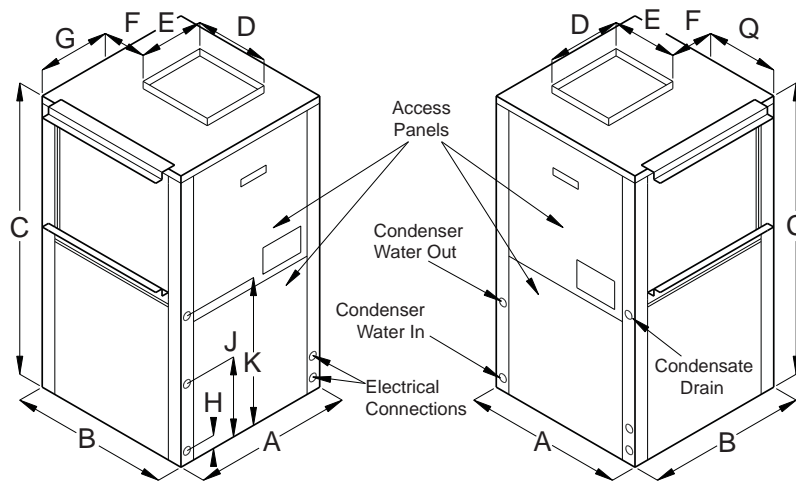

Left Hand Return (FLT)

Right Hand Return (FRT)

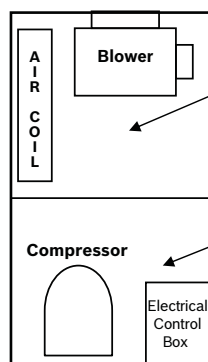

Front of Unit
Service Clearances

Blower Access
18" Minimum
24" Optimum

Compressor Access and
Electrical/Control Access
24" Minimum
36" Optimum

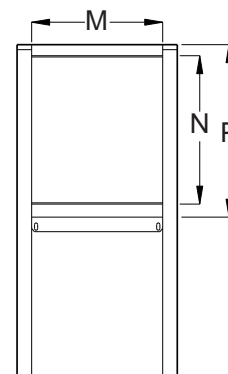

Return Air (Filter) View

NOTE: The local electric codes may require 36" or more clearance at the electrical control box.

Subject to change without prior notice.

Horizontal Unit Dimensions

Overall unit dimensions do not include filter rack or duct flanges.

Model	A	B	C	D	E	F	G	H	J	K	M	N	P	Q	R	T	Condenser Water Connections	Recommended Replacement Nominal Filter Size
	Width	Depth	Height	Filter Rack End to Cabinet	R/A Duct Width	Cab Front to Filter Rack	Water Inlet	Water Outlet	Side to Discharge (End)	Discharge Width	Top to Discharge (FLE & FRS)	Discharge Height	End to Discharge (Straight)	End to Discharge (FRE & FLS)	Top to Discharge (FRE & FLS)	Filter Rack Height		
LV007	19.0	33.0	11.5	1.5	16.15	15.35	2.38	9.5	5.375	6.3	5.97	4.1	4.875	1.41	11.3	8.6	3/4" FPT	10 × 16 × 1
LV009	19.0	33.0	11.5	1.5	16.15	15.35	2.38	9.5	5.375	6.3	5.97	4.1	4.875	1.41	11.3	8.6	3/4" FPT	10 × 16 × 1
LV012	19.0	33.0	11.5	1.5	16.15	15.35	2.38	9.5	5.25	6.43	6.31	4.1	4.75	1.14	11.3	8.6	3/4" FPT	10 × 16 × 1
LV015	22.0	43.0	17.0	1.5	20.15	21.35	2.86	15.0	5.42	9.13	6.11	9.65	4.92	1.23	16.8	15.0	3/4" FPT	16 × 20 × 1
LV018	22.0	43.0	17.0	1.5	20.15	21.35	2.86	14.13	5.42	9.13	6.11	9.65	4.92	1.23	16.8	15.0	3/4" FPT	16 × 20 × 1
LV024	22.0	43.0	17.0	1.5	25.0	16.5	2.86	14.13	5.42	9.13	6.11	9.65	4.92	1.23	16.8	15.0	3/4" FPT	16 × 25 × 1
LV030	22.0	43.0	17.0	1.5	25.0	16.5	2.47	15.0	5.42	9.13	6.11	9.65	4.92	1.23	16.8	15.0	3/4" FPT	16 × 25 × 1
LV036	22.0	54.5	19.0	1.5	30.15	22.85	2.86	16.13	6.47	9.13	7.5	10.28	5.97	1.21	18.8	17.0	3/4" FPT	18 × 30 × 1
LV042	22.0	54.5	19.0	1.5	30.15	22.85	2.86	16.13	5.27	10.45	6.46	11.3	4.77	1.22	18.8	17.0	3/4" FPT	18 × 30 × 1
LV048	25.0	54.5	21.0	1.5	34.6	18.4	2.86	18.52	7.25	10.45	7.46	11.36	6.75	2.16	20.8	19.0	1" FPT	20 × 34.5 × 5 × 1
LV060	25.0	54.5	21.0	1.5	34.6	18.4	2.86	18.52	6.32	11.76	6.81	12.5	5.82	1.68	20.8	19.0	1" FPT	20 × 34.5 × 5 × 1
LV070	25.0	65.0	21.0	1.5	48.1	15.4	2.86	18.52	6.32	11.76	6.81	12.5	5.82	1.68	20.8	19.0	1" FPT	20 × 24 × 1 (2)

All dimensions within $\pm 0.125"$. All condensate drain connections are 3/4" FPT. LV015-070 can be field converted between end blow and straight through supply air configurations. Specifications subject to change without notice.

1" filter rack extends 1.23" beyond the side of the unit. 2" filter rack extends 2.89" beyond the side of the unit.

The 2" filter rack is 4 sided with a filter access door on one end and can accept either a 1" or 2" filter.

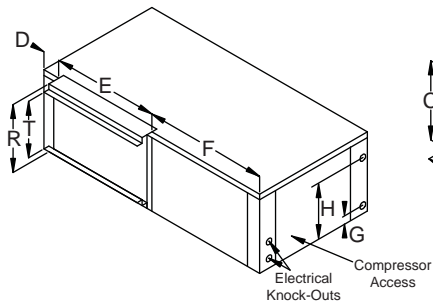

Left Hand Return End Blow (FLE)

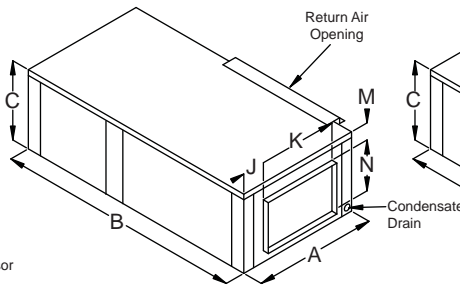

Left Hand Return Straight Through (FLS)

Models LV048 & 060 Left Hand Return units have condenser water connections on the front right and electrical knockouts on the front left.

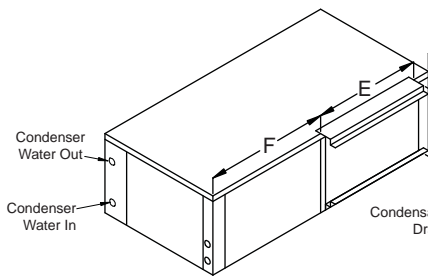

Right Hand Return End Blow (FRE)

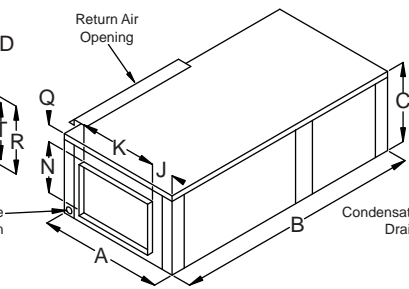

Right Hand Return Straight Through (FRS)

Service Clearances

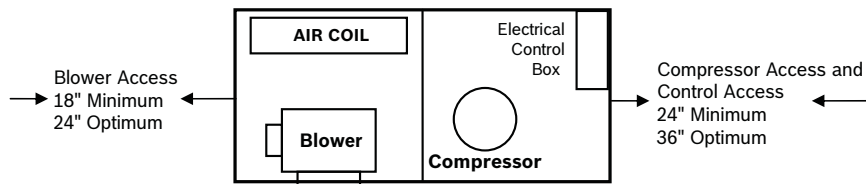

NOTE: The local electric codes may require 36" or more clearance at the electrical control box.

Subject to change without prior notice.

Counterflow Unit Dimensions

Overall unit dimensions do not include filter rack or duct flanges.

Model	A	B	C	D	E	F	G	H	J	K	M	N	P	Q	Condenser Water Connections	Recommended Replacement Nominal Filter Size
	Width	Depth	Height	Discharge Depth	Discharge Width	Cabinet Edge to Discharge	Left Side to Discharge	Water Inlet	Water Outlet	Condensate Drain	R/A Duct Width	R/A Duct Flange Height	Filter Rack Height			
LV015	21.5	21.5	32.25	9.7	9.0	5.9	6.8	19.9	25.5	1.0	20.0	14.0	16.0	6.7	3/4" FPT	16x20x1
LV018	21.5	21.5	32.25	9.7	9.0	5.9	6.8	19.9	25.5	1.0	20.0	14.0	16.0	6.7	3/4" FPT	16x20x1
LV024	21.5	21.5	39.25	9.7	9.0	5.9	6.8	23.9	36.0	1.0	20.0	18.0	20.0	6.7	3/4" FPT	20x20x1
LV030	21.5	21.5	39.25	9.7	9.0	5.9	6.8	23.9	36.0	1.0	20.0	18.0	20.0	6.7	3/4" FPT	20x20x1
LV036	21.5	26	43.25	10.3	9.2	7.8	6.2	27.8	35.8	1.0	24.0	22.0	24.0	6.2	3/4" FPT	24x24x1
LV042	21.5	26	43.25	11.3	10.5	7.4	5.9	27.8	35.8	1.0	24.0	22.0	24.0	5.9	3/4" FPT	24x24x1
LV048	24	32.5	45.25	11.4	10.5	10.5	6.7	28.3	38.3	1.0	30.0	22.0	24.0	6.7	1" F.P.T.	24x30x1
LV060	24	32.5	45.25	12.5	11.7	10.0	6.1	28.3	38.3	1.0	30.0	22.0	24.0	6.1	1" F.P.T.	24x30x1
LV070	26	33.25	58.25	12.5	11.7	10.3	7.2	36.0	46.4	1.0	30.0	30.0	32.0	7.1	1" F.P.T.	16x30x1 (2)

All dimensions within +- 0.125". All condensate drain connections are 3/4" FPT. LV015-070 can be field converted between end blow and straight through supply air configurations. Specifications subject to change without notice.

1" filter rack extends 1.23" beyond the side of the unit. 2" filter rack extends 2.89" beyond the side of the unit. The 2" filter rack is 4 sided with a filter access door on one end and can accept either a 1" or 2" filter.

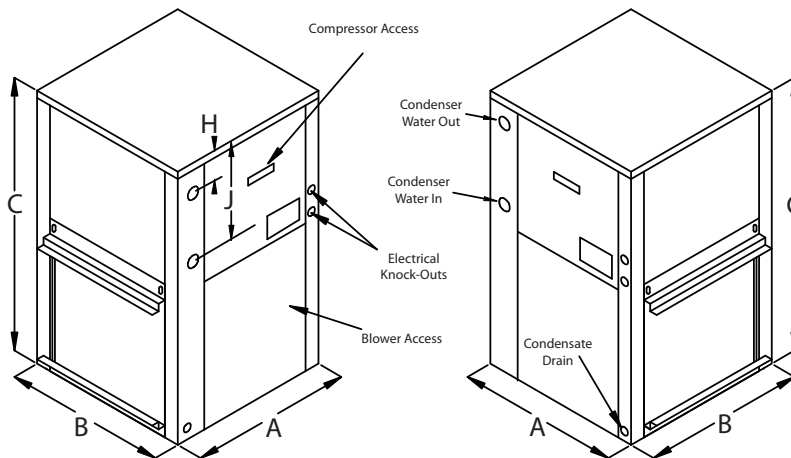

Left Hand Return (FLB)

Right Hand Return (FRB)

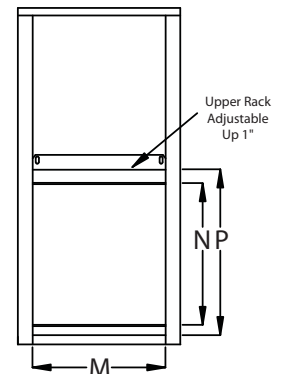

Return Air (Filter) View

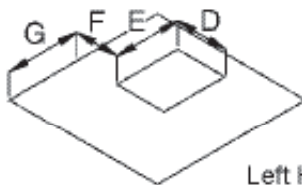

Left Hand Return (FLB)

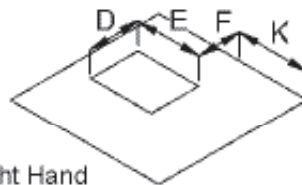

Right Hand Return (FRB)

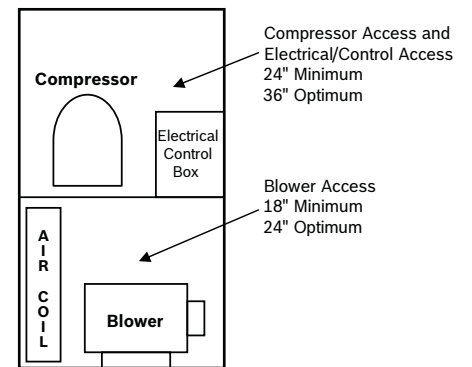

Front of Unit Service Clearances

NOTE: The local electric codes may require 36" or more clearance at the electrical control box.

Subject to change without prior notice.

Guide Specification

1.0 General

Furnish and install FHP water source heat pumps as indicated on the plans with capacities and characteristics as listed in the schedule and the specifications that follow. The units shall be manufactured in an ISO 9001:2000 certified facility.

2.0 Horizontal/Vertical/Counterflow Water Source Heat Pumps

The units shall be designed to operate with entering fluid temperatures between 50°F (10°C) and 100°F (38°C) in cooling and between 50°F (10°C) and 80°F (27°C) in heating. With the optional factory installed extended range package, units shall operate with entering fluid temperatures between 50°F (10°C) and 110°F (43.3°C) in cooling and between 20°F (-6.6°C) and 80°F (27°C) in heating. Equivalent units from other manufacturers can be proposed, provided approval to bid is given 10 days prior to bid closing. All equipment with a nominal capacity of 135,000 BTUH Total Cooling or lower must be listed in the current AHRI Applied Equipment Directory under the AHRI Standard AHRI/ISO- 13256-1, WLHP, GWHP and GLHP certification points.

All equipment in this section must meet or exceed the DOE mandated minimum EER's and COP's as listed in ASHRAE 90.1 as follows:

For the AHRI/ISO-13256-1, WLHP Rating (12.0 EER and 4.2 COP for units larger than a nominal 17,000 BTUH Total Cooling – 11.2 EER and 4.2 COP for units below a nominal 17,000 BTUH Total Cooling).

For the AHRI/ISO-13256-1, GLHP Rating a minimum 13.4 EER and 3.1 COP. All units shall be listed with Underwriters Laboratories (UL) for safety.

2.01 Basic Construction

- A. Units shall have the airflow arrangement as shown on the plans. If units with these arrangements are not used, the contractor supplying the water source heat pumps is responsible for any extra costs incurred by other trades and must submit detailed mechanical drawings showing ductwork requirements and changes or relocation of any other mechanical or electrical system. If other arrangements make servicing difficult, the contractor must provide access panels and clear routes to ease service. The architect must approve all changes 10 days prior to bid.
- B. All units shall have stainless steel drain pans to comply with this project's IAQ requirements. Painted steel or plastic is not acceptable.
- C. The cabinet shall be fabricated from heavy-gauge galvanized steel for superior corrosion protection. All interior surfaces shall be lined with 1/2" (12.7mm) thick, multi density, coated, glass fiber insulation. Insulation within the air handling section shall not have any exposed edges. All insulation must meet NFPA 90A and be certified to meet the GREENGUARD® Indoor Air Quality Standard for Low Emitting Products. One blower access panel and two compressor compartment access panels shall be removable with supply and return air ductwork in place.
- D. Unit shall have a floating compressor or pan consisting of a 1/2" (12 mm) thick high density elastomeric pad between the compressor base plate and the unit base pan to prevent transmission of vibration to the structure.
- E. Units shall have a 1" filter rack and 1" thick throw-away type glass fiber filter as standard. Units shall have an optional 2" thick pleated MERV 8 filter (size 007-070) or MERV 13 filter (size 015 and larger with upgraded ECM) available. The filter rack shall incorporate a 1" duct flange. The units shall have an insulated divider panel between the air handling section and the compressor section to minimize the transmission of compressor noise, and to permit service testing without air bypass.
- F. Cabinets shall have separate holes and knockouts for entrance of line voltage and low voltage control wiring.

Supply and return water connections shall be brass female pipe thread fittings and mounted flush to cabinet exterior. Connections that require a back up wrench or that extrude past the unit corner post are not acceptable. Condensate connections will be stainless steel female pipe thread fittings. Plastic is not acceptable.
- G. Hanging brackets shall be provided as standard for horizontal units.

Guide Specification

2.02 Fan and Motor Assembly

- A. The fan shall be direct-drive centrifugal forward curved type with a dynamically balanced wheel. The housing and wheel shall be designed for quiet low velocity operation. The blower housing shall feature a removable inlet ring to facilitate removal and servicing of the fan motor. The fan motor shall be 3-speed, permanently lubricated, PSC type with thermal overload protection.
- B. 15,000 Btu/Hr to 70,000 Btu/Hr models shall have an optional constant torque electronically commutated motor for premium fan efficiency. These motors shall feature 5 pre-programmed torque settings that can be changed in the field to match design requirements. 460 V – 3 Ph – 60 Hz units with these motors must be able to operate without the need for a neutral wire for the motor.
- C. 15,000 Btu/Hr to 70,000 Btu/Hr models shall have an optional constant CFM electronically commutated motor for premium fan efficiency and constant air delivery over a wide range of external static pressures. These motors shall be field adjustable for +/- 15% of nominal design airflow. These motors shall provide feedback to the unit control box to verify motor operating mode and delivered CFM.

2.03 Refrigerant Circuit

Units shall use R-410A refrigerant. All units shall have a factory sealed and fully charged refrigerant circuit with the following components:

- A. Hermetic compressor: Hermetic reciprocating, rotary, or scroll compressors shall be specifically designed for R-410A refrigerant and shall be internally sprung (if reciprocating), externally isolated and with thermal overload protection.
- B. Refrigerant metering thermal expansion valves or capillary tubes.
- C. The finned tube heat exchanger shall be constructed of lanced aluminum fins not exceeding sixteen fins per inch bonded to rifled copper tubes in a staggered pattern and will have a 600 PSIG (4140 kPa) working pressure. The heat exchanger shall have aluminum end sheets.

Optional Air Coil Protection: The finned tube heat exchanger shall have optional DuoGuard™ protective coil coating. This corrosion protection shall consist of tin plated copper tubing with coated aluminum fins that must pass 1000 hours of ASTM B117 salt fog testing. Painted, dipped or e-coated heat exchangers are not acceptable.

- D. Reversing valve. Reversing valves shall be four-way solenoid activated refrigerant valves which shall fail to the heating operation should the solenoid fail to function. Reversing valves which fail to the cooling operation shall not be allowed.
- E. Coaxial (tube in tube) refrigerant to water heat exchanger. Refrigerant to water heat exchangers shall be of copper inner water tube and steel outer refrigerant tube design rated to withstand 600 PSIG working refrigerant pressure and 400 PSIG working water pressure. Shell and Tube style refrigerant to water heat exchangers shall be treated as pressure vessels and shall require refrigerant pressure relief valves piped to the exterior of the building. The contractor supplying the water source heat pumps with Shell and Tube heat exchangers shall be responsible for any additional installation costs. Brazed Plate water to refrigerant heat exchangers shall require additional centrifugal separators added to the supply water piping at each unit. Each separator shall have an automated clean out valve piped to a waste line. The contractor supplying water source heat pumps with Brazed Plate heat exchangers shall be responsible for any additional costs.

Option for E: Cupro-Nickel water coil – The refrigerant to water heat exchanger shall be of Cupro-Nickel inner water tube construction.

- F. Safety controls include both a high pressure and low pressure switch. Temperature sensors shall not replace these safety switches. See the controls section of this specification for additional information.
- G. Access fittings shall be factory installed on high and low pressure refrigerant lines to facilitate field service.

Guide Specification

H. Activation of any safety device shall prevent compressor operation via a lockout circuit. The lockout circuit shall be reset at the thermostat or at the contractor supplied disconnect switch. Units which may be reset at the disconnect switch only shall not be acceptable. Refer to solid state safety circuit below.

2.04 Electrical

Controls and safety devices will be factory wired and mounted within the unit. Controls shall include fan relay, compressor contactor, 24V transformer, reversing valve coil and solid state lockout controller, Unit Protection Module (UPM). The standard transformer shall be rated for a minimum 50 VA. All units shall be name-plated for use with time delay fuses or HACR circuit breakers. Unit controls shall be 24 volts.

Option: Optional transformers shall be rated 75VA and shall have a push button reset circuit breaker on the secondary power.

2.05 Solid-State Safety Circuit

All units shall have a solid-state UPM safety control circuit with the following features:

1. Anti-short cycle time delay (5 minute delay on break).
2. Random start time delay on initial power.
3. Brown out/surge/power interruption protection.
4. 120 second low pressure switch bypass timer.
5. High refrigerant pressure shutdown.
6. Low refrigerant pressure shutdown.
7. Low water temperature shutdown (adjustable for closed loop systems).
8. Air coil freeze protection shutdown.
9. High condensate level shutdown.
10. 24 VAC alarm output for remote fault indication.

The UPM shall automatically reset after a safety shutdown. Restart the unit if the cause of the shutdown no longer exists (except for low temperature and high condensate level shutdowns). Should a fault re-occur within 60 minutes after reset, then a "hard" lockout will occur. A light emitting diode (LED) shall announce the following alarms: brown out, high

refrigerant pressure, low refrigerant pressure, low water temperature and a high level of condensate in the drain pan. The LED will display each fault condition as soon as the fault occurs. If a hard lockout occurs, then the fault LED will display the type of fault until the unit is reset.

The UPM shall feature the following field configurable adjustments:

1. Lock out reset on thermostat interruption or power reset.
2. 2 or 4 restart attempts before a hard lockout.
3. Test mode (reduces all time delays to 5 seconds for diagnostic work).
4. Antifreeze setting for low water temperature sensor.

Safety devices include:

1. Low pressure cutout set a 40 PSIG (280 kPA) for loss of charge protection (freezestat and/or high discharge gas temperature sensor is not acceptable).
2. High pressure cutout control set at 600 PSIG (4125 kPA).
3. Low supply water temperature sensor that detects drops in refrigerant temperature that could result in water coax heat exchanger freezing.
4. Low air coil temperature sensor that detects drops in refrigerant temperature that could result in air heat exchanger freezing.
5. High level condensate sensor that shuts off the compressor if the condensate drain pan fills with water.
6. On board voltage detection that disables the compressor control circuit if there are extreme variations in supply voltage.

An optional energy management relay that allows unit control by an external source shall be factory installed. A terminal block with screw terminals shall be provided for control wiring.

2.06 Options

- A. Units shall have an optional 2-way electrically operated shut-off valve mounted internally in the unit cabinet.
- B. Units shall have an optional water flow regulating valve set to 3 gallons per minute of water flow per nominal ton of refrigeration capacity.

Guide Specification

- C. Extra quiet construction: Optional compressor blanket shall be provided on units having a capacity above 18,000 BTUH.
- D. Hot Gas Reheat: Units as noted on the schedule shall be equipped with optional Hot Gas Reheat (HGRH) on units having a capacity above 12,000 BTUH. HGRH shall be either on/off control or modulating as noted in the specifications.

On/Off HGRH shall be controlled by a humidistat connected to the unit H terminal and shall start the unit in the reheat mode should the humidity be above set-point once the thermostat control is satisfied. Cooling or heating requirements shall take precedent over HGRH.

Modulating Hot Gas Reheat (MHGRH) shall be active during the cooling mode. A 0 - 10 VDC signal from a sensor located in the unit discharge air supply shall modulate the hot gas valve to maintain an adjustable preset leaving air temperature to the conditioned space.

- E. Hot Gas Bypass: For units as noted on the schedule, supply each unit with a ETL listed modulating hot gas bypass valve with factory supplied and installed controls to prevent air coils from frost development by taking hot gas and bypassing the water coil and expansion device and reintroducing the hot gas into the refrigerant line prior to the air coil. The hot gas bypass valve shall maintain a minimum refrigerant suction pressure to allow for a light load cooling mode or a low entering air temperature cooling mode.
- F. Water Differential Pressure Switch: Prevents unit operation if there is no fluid flow. This factory installed, internally mounted device shall be rated at 600psi and disable the compressor if a lack of water-flow occurs.
- G. Water Side Economizer: Water side economizer shall be completely installed at the factory, with an additional condensate drain pan, motorized 3 way valve, aqua stat, and all internal electric controls. Water side economizer shall be rated at 400 psi and UL listed for application with the heat pump. This option is externally mounted outside the unit.

- H. Factory-installed control options: Water differential pressure switch, 75 VA transformer (resettable), phase loss and reversal protection, and unit mounted disconnect switch.
- I. A 2", four-sided filter rack is optional to accommodate nominal 2" thick pleated filters.
- J. DDC Controls: Unit shall be equipped with a factory installed DDC control capable of interfacing with BacNet, Modbus, N2 and Lonworks. The controller shall be pre-programmed to control the unit and monitor the safety controls. The unit shall be able to operate as a standalone or be incorporated into the building management system. A leaving water and leaving air sensor shall be installed in the unit. Wall sensors shall be available for controlling zone temperature.

3.0 Hose Kits

All units shall be connected with hoses. The hoses shall be either 2 or 3 feet long, braided stainless steel, fire rated hoses complete with adapters. Non-fire rated hoses are not acceptable. Optional ball valves with P/T ports, flow controller, Y strainer and electric valve shall be included as specified in the schedule.

Bosch Thermotechnology Corp.

555 NW 65th Court, Fort Lauderdale, FL 33309
Phone: 866-642-3198 | Fax: 954-776-5529
www.boschheatingandcooling.com

Printed on Elemental Chlorine Free, FSC-certified,
minimum 10% PCW paper with vegetable-based inks.
Scan QR code to the right to access product information.

BTC 760304301 E | 02.2018

Copyright © 2014 Bosch Thermotechnology Corp.
All rights reserved. Subject to change without notice.

