

GreenSource i series Model BP Residential Geothermal Heat Pumps

Engineering
Submittal
Sheet



BOSCH

Overview and Certifications



Standard Features, Factory Installed Options, and Field Installed Accessories

Standard Features

- ▶ **Available in Horizontal and Vertical Cabinets**
 - Constructed using white pre-painted steel
 - Hanging brackets standard for horizontal cabinet
- ▶ **High Efficiency**
 - Up to 21.2 EER @ FL GLHP
 - Compliant with Energy Start Tier 3
 - PSC blower motor for unit size 012
 - Constant Torque ECM for unit sizes 018-048
- ▶ **Configured as Ordered**
 - Left hand or right hand return air
 - Top or end supply air
- ▶ **½" Dual Density Fiber Insulation**
 - Non-combustible, non-hydroscopic and does not support fungal growth
 - Meets NFPA 90A AND 90B for fire protection
 - Meets the GREENGUARD Indoor Air Quality Standard
- ▶ **Compressors**
 - Floating compressor base pan for quiet operation
 - 012 - 018 Rotary
 - 024 - 048 Scroll
- ▶ **Standard MERV 8 Filter with 4 sided Filter Rack**
- ▶ **TXV (Thermal Expansion Valve)**
 - Improves refrigerant management and efficiencies
- ▶ **Reliability - Durability - Serviceability**
 - UPM circuit board with communicating features
 - Completely serviceable from front of unit
- ▶ **DuoGuard™ Evaporator Coil**
 - Tin electro-plated copper tubing with high-tech polymer coated aluminum fins will protect the evaporator coil from all forms of corrosive elements in the airstream

Standard Features, Factory Installed Options, and Field Installed Accessories continued..

▶ **Electronic Circuit Board UPM**

The electronic circuit board provides protection with:

- Random Start of Unit
- 5 minute short cycle time delay (Anti-Short Cycling)
- Alarm communicating Output
- Low pressure switch bypass at cold water start up

It also monitors and communicates standard safety features/alerts/operation/protection:

- Low Pressure Switch
- High Pressure Switch
- Evaporator Freeze Switch
- Water Coil Freeze Switch
- Condensate Overflow Switch

This circuit board can communicate with a Bosch thermostat that alerts the customer of adverse conditions

▶ **Standard 75 VA Transformer**

▶ **Standard Warranty**

- 10 year all parts limited warranty
- 10 year labor limited warranty
- For full warranty details: <https://www.bosch-homecomfort.com/us/en/residential/service/product-warranty-library/heat-pump-geothermal-warranty-documents/>

▶ **Field Configurable Horizontal Discharge Air Conversion**

- This allows end blow to straight through conversion of discharge air, as the straight through configuration for horizontal is no longer available

Field Installed Accessories

▶ **Thermostats**

- Bosch thermostats are fully customized to meet your individual needs. Bosch offers communicating thermostats that can display alert messages without having to go to the unit

▶ **Externally Mounted Duct Heater Kits**

▶ **Swivel Water Connections**

- 3/4" or 1" FPT Swivel Water Connection depending on unit size

▶ **Internally Mounted Electric Heater Kits**

- A field installed option for back up heat. Available in 5, 10, 15, or 20 kW depending on the size of the geothermal heat pump

▶ **Pump/Valve Relay Kit**

- This relay is used to energize a supply pump or solenoid valve when there is a call for compressor operation. This relay can be used to switch either high or low voltage power

▶ **SmartStart Assist Kit**

- An option which provides a means of reducing inrush currents at compressor startup. Light flickering is eliminated, and a smooth start is achieved (only available on scroll compressor models)

▶ **Stainless Steel Hose Kits**

- Available in various lengths and diameters depending on the need for your application

▶ **Flow Center Kits**

GreenSource i Series Model BP Residential Geothermal Heat Pumps



Model Nomenclature

BP 018 - 1 VTC - F L T T D B - X G G X X X X X 7 X X X X 4 X X X X S B A
 1-2 3-5 6 7 8-9 10 11 12 13 14 15 16 17 18 19 20 21 22 23 24 25 26 27 28 29 30 31 32 33 34 35 36 37 38 39 40

MODEL:
BP

NOMINAL CAPACITY:
012, 018, 024
030, 036, 042
048

ELECTRICAL CONFIGURATION:
1 - 208-230/60/1

CABINET CONFIGURATION:
HZ - Horizontal
VT - Vertical

COAX OPTIONS:
C - Copper
N - Cupro-nickel

WATER CONNECTIONS:
F - Front

RETURN AIR CONFIGURATION:
L - Left
R - Right

DISCHARGE AIR LOCATION:
T - Top
E - End

FAN/MOTOR OPTION:
P - Standard PSC
T - Constant Torque ECM

AIR COIL:
D - DuoGuard

REVISION LEVEL:
B - Current
C - Current

ELECTRIC HEAT:
X - None

CABINET CONSTRUCTION:
G - Painted Steel / 1/2" Standard 1.5 LB Dual Density Fiberglass

APPLICATION:
G - Extended Range (Geothermal)

CODE STRING LEVEL:
A - Revision

CHANNEL:
B - Bosch

STANDARD/SPECIAL:
SS - Standard
AA - Special #1
AB - Special #2

NOT USED:
X - None

NOT USED:
X - None

BLOWER PULLEY (BELT DRIVE ONLY):
X - N/A

MOTOR SHEAVE (BELT DRIVE ONLY)
X - N/A

AIR FILTRATION:
4 - 2" MERV8 w/ 4-sided Filter Rack

NOT USED:
X - None

ECONOMIZER:
X - None

WATER FLOW CONTROL OPTIONS:
X - None

CONTROLS:
X - Standard (UPM)

TRANSFORMER:
7 - 75 VA

REFRIGERATION:
X - None

ELECTRICAL OPTIONS:
X - As default for non used electrical codes

GreenSource i Series Model BP
Residential Geothermal Heat Pumps



ASHRAE/AHRI/ISO 13256-1. with PSC Motor

Model Number	Water Loop Heat Pump				Ground Water Heat Pump				Ground Loop Heat Pump				Fluid Flow Rate (GPM)	Air Flow Rate (CFM)
	Cooling Capacity (Btu/hr)	EER	Heating Capacity (Btu/hr)	COP	Cooling Capacity (Btu/hr)	EER	Heating Capacity (Btu/hr)	COP	Cooling Capacity (Btu/hr)	EER	Heating Capacity (Btu/hr)	COP		
BP012	12200	14.90	14600	5.00	14200	22.70	12000	4.30	12600	17.50	9300	3.60	4.0	400

ASHRAE/AHRI/ISO 13256-1 with ECM Motor

Model Number	Water Loop				Ground Water				Ground Loop				Fluid Flow Rate (GPM)	Air Flow Rate (CFM)
	Cooling Capacity (Btu/hr)	EER	Heating Capacity (Btu/hr)	COP	Cooling Capacity (Btu/hr)	EER	Heating Capacity (Btu/hr)	COP	Cooling Capacity (Btu/hr)	EER	Heating Capacity (Btu/hr)	COP		
BP018 VT	19500	15.90	21300	5.00	21300	25.30	17700	4.40	20500	18.50	14800	3.70	5.0	650
BP018 HZ	19500	15.40	21300	5.00	21300	24.70	17700	4.40	20500	17.90	14800	3.65	5.0	650
BP024	24500	16.95	28500	5.15	28400	27.35	23700	4.50	26000	19.80	18000	3.70	6.0	850
BP030	27000	16.60	31000	5.70	31000	27.00	25000	4.95	28500	19.40	20300	3.95	7.0	1000
BP036 VT	36000	17.10	41000	5.50	40200	25.90	34400	4.90	37500	19.70	26000	3.90	10.0	1200
BP036 HZ	36000	16.10	41000	5.35	40200	24.30	34400	4.70	37500	18.70	26000	3.90	10.0	1200
BP042 VT	38400	15.20	42400	5.50	44100	25.60	35000	4.65	40600	19.40	26800	3.70	10.5	1400
BP042 HZ	38400	17.15	42400	5.80	44100	27.20	35000	5.00	40600	19.50	26800	4.00	10.5	1400
BP048 VT	44400	15.00	50000	5.25	51100	24.00	40500	4.30	46800	17.75	33400	3.70	12.0	1600
BP048 HZ	44400	15.00	50000	5.25	51100	24.00	40500	4.50	46800	17.80	33400	3.70	12.0	1600

GreenSource i Series Model BP
Residential Geothermal Heat Pumps



Physical Data								
Description	Unit	Model Size						
		012	018	024	030	036	042	048
Compressor Type	—	Rotary	Rotary	Scroll	Scroll	Scroll	Scroll	Scroll
Max Water Working Pressure	PSIG/kPa	400/3100	400/3100	400/3100	400/3100	400/3100	400/3100	400/3100
Standard Fan Motor & Blower								
Fan Motor Type/Speeds	—	PSC/3	ECM Const Torque / 3 speed	ECM Const Torque / 3 speed	ECM Const Torque / 3 speed	ECM Const Torque / 3 speed	ECM Const Torque / 3 speed	ECM Const Torque / 3 speed
Fan Motor (HP)	HP	1/10	1/3	1/3	1/2	3/4	3/4	3/4
Blower Wheel Size (Dia. x W)	Inch	5.5x5.5	9x7	9x7	9x7	9x7	10x8	10x8
Water Connection Size								
FPT	Inch	3/4	3/4	3/4	1	1	1	1
Coaxial Coil Volume	gal	0.31	0.31	0.48	0.39	0.62	0.62	0.62
Vertical Cabinet								
Refrigeration Charge	oz	30	34	65	71	68	83	86
Air Coil Dimensions (H x L)	Inch	16x16.5	16.5x20	24x21	24x27	24x27	32x27	32x27
Standard Filter - 2" MERV 8 (H x L)	Inch	18x20	20x20	24x24	24x30	24x30	16x30 (2)	16x30 (2)
Weight - Operating	Lbs	166	195	229	269	281	334	340
Weight - Shipping	Lbs	186	212	242	292	304	360	366
Horizontal Cabinet								
Refrigeration Charge	oz	46	35	65	71	71	80	82
Air Coil Dimensions (H x L)	Inch	16x16.5	18x18.5	18x28	20x32.5	20x32.5	20x43.25	20x43.25
Standard Filter - 2" MERV 8 (H x L)	Inch	18x20	18x20	20x30	20x34.5	20x34.5	20x24 (2)	20x24 (2)
Weight - Operating	Lbs	173	198	307	358	369	400	405
Weight - Shipping	Lbs	205	222	340	404	415	465	470

GreenSource i Series Model BP
Residential Geothermal Heat Pumps



Horizontal Cabinet Corner Weights										
Configuration			Left Hand Evaporator				Right Hand Evaporator			
Model	Unit	Total	Left Front*	Right Front*	Left Back	Right Back	Left Front*	Right Front*	Left Back	Right Back
BP012	Lbs	173	46	42	45	40	44	44	40	45
	kg	79	21	19	21	18	20	20	18	21
BP018	Lbs	198	51	49	50	48	49	51	47	51
	kg	90	23	22	23	22	22	23	22	23
BP024	Lbs	307	80	78	79	70	77	81	68	81
	kg	140	36	36	36	32	35	37	31	37
BP030	Lbs	358	99	88	92	79	96	92	78	92
	kg	163	45	40	42	36	44	42	35	42
BP036	Lbs	369	100	92	94	83	96	96	81	96
	kg	168	45	42	43	38	44	44	36	44
BP042	Lbs	400	107	99	105	89	103	103	88	106
	kg	182	49	45	48	40	47	47	40	48
BP048	Lbs	405	106	108	102	89	102	112	85	106
	kg	184	48	49	46	41	46	51	39	48

*Front is control box end

Factory Installed Option - Cupro-Nickel Coil	
Model Number with Standard Copper Coil	Model Number with Cupro-Nickel Coil (To add this option to the product, change the model number 10TH digit* to an "N")
BP012-1HZC	N/A
N/A	N/A
BP018-1HZC	BP018-1HZN
BP018-1VTC	BP018-1VTN
BP024-1HZC	N/A
BP024-1VTC	N/A
N/A	BP030-1HZN
BP030-1VTC	BP030-1VTN
BP036-1HZC	BP036-1HZN
BP036-1VTC	BP036-1VTN
N/A	BP042-1HZN
BP042-1VTC	BP042-1VTN
N/A	BP048-1HZN
BP048-1VTC	BP048-1VTN

* dashes are included as a digit.

GreenSource i Series Model BP Residential Geothermal Heat Pumps



Electrical Data - Standard Motor - PSC for 012

Model	Voltage Code	Voltage/Hz/Phase	Compressor				Blower Motor			Unit FLA	Min Circuit Amps	MOP CALC	MOP
			QTY	Model	RLA	LRA	QTY	FLA	HP				
BP012	1	208-230/60/1	1	RGA5494BXD	4.6	27.9	1	0.96	0.1	5.56	6.7	11.3	15

Electrical Data - Standard Motor - ECM Constant Torque for 018-048

Model	Voltage Code	Voltage/Hz/Phase	Compressor				Blower Motor			Unit FLA	Min Circuit Amps	MOP CALC	MOP
			QTY	Model	RLA	LRA	QTY	FLA	HP				
BP018	1	208-230/60/1	1	GK151KAAA3	7.4	33	1	2.8	0.33	10.2	12.1	19.5	15
BP024	1	208-230/60/1	1	ZP20K5EPFV	13.5	58.3	1	2.8	0.33	16.3	19.7	33.2	30
BP030	1	208-230/60/1	1	ZP21K5EPFV	12.8	58.3	1	2.8	0.33	15.6	18.8	31.6	30
BP036	1	208-230/60/1	1	ZP28K5EPFV	16	77	1	4.3	0.5	20.3	24.3	40.3	40
BP042	1	208-230/60/1	1	ZP31K6EPFV	15.4	83.9	1	6.8	0.75	22.2	26.1	41.5	40
BP048	1	208-230/60/1	1	ZP38K5EPFV	19.9	109	1	6.8	0.75	26.7	31.7	51.6	50

i 208/230V Units shipped with transformer wired for 230V—for 208V remove orange transformer primary lead and replace with red lead.

Electrical Data - Field Install Internal Electric Heat Accessory - 1st Data Plate for Compressor Power Connection

Models	Voltage Code	Voltage/Hz/Phase	Voltage Min/Max	Compressor				FLA (Amps)	Min Circuit Amps	MOP CALC	Max Fuse/HACR
				Model	QTY	RLA	LRA				
BP018	1	208-230/60/1	197/253	GK151KAAA3	1	7.4	33.0	7.4	9.3	16.7	15
BP024	1	208-230/60/1	197/253	ZP20K5EPFV	1	13.5	58.3	13.5	16.9	30.4	30
BP030	1	208-230/60/1	197/253	ZP21K5EPFV	1	12.8	58.3	12.8	16.0	28.8	25
BP036	1	208-230/60/1	197/253	ZP28K5EPFV	1	16.0	77.0	16.0	20.0	36.0	35
BP042	1	208-230/60/1	197/253	ZP31K6EPFV	1	15.4	83.9	15.4	19.3	34.7	35
BP048	1	208-230/60/1	197/253	ZP38K5EPFV	1	19.9	109.0	19.9	24.9	44.8	40

GreenSource i Series Model BP
Residential Geothermal Heat Pumps



Electrical Data - Electric Heat Option - 2nd Data Plate for Constant Torque ECM												
Model	EH RATED kW	STAGE	Heater Watts		Heater AMPS		Motor FLA (A)	Circuit Fuses	MCA		MOP	
			240	208	240V	208V			240V	208V	240V	208V
BP018	4.8	1	4,800	3,600	20.0	17.3	2.8	-	28.5	25.1	30	30
BP024	4.8	1	4,800	3,600	20.0	17.3	2.8	-	28.5	25.1	30	30
BP024	9.6	1	9,600	7,200	40.0	34.6	2.8	-	53.5	46.8	60	50
BP030	4.8	1	4,800	3,600	20.0	17.3	4.1	-	30.1	26.8	35	30
BP030	9.6	1	9,600	7,200	40.0	34.6	4.1	-	55.1	48.4	60	50
BP036	4.8	1	4,800	3,600	20.0	17.3	6.0	-	32.5	29.1	35	30
BP036	9.6	1	9,600	7,200	40.0	34.6	6.0	-	57.5	50.8	60	60
BP036	14.4	2	14400	10800	60	51.9	6	F1/F2 F3/F4	82.5	72.4	90	80
BP042	4.8	1	4,800	3,600	20.0	17.3	6.0	-	32.5	29.1	35	30
BP042	9.6	1	9,600	7,200	40.0	34.6	6.0	-	57.5	50.8	60	60
BP042	14.4	2	14400	10800	60	51.9	6	F1/F2 F3/F4	82.5	72.4	90	80
BP048	4.8	1	4,800	3,600	20.0	17.3	6.0	-	32.5	29.1	35	30
BP048	9.6	1	9,600	7,200	40.0	34.6	6.0	-	57.5	50.8	60	60
BP048	14.4	2	14400	10800	60	51.9	6	F1/F2 F3/F4	82.5	72.4	90	80
BP048	19.2	2	19200	14000	80	69.2	6	F1/F2 F3/F4	107.5	94.0	110	100

Greensource i Series Model BP
Residential Geothermal Heat Pumps



BOSCH

Operating Limits - Cooling & Heating	
Description	Standard Unit
COOLING	
Minimum ambient air temperature °F	50
Maximum ambient air temperature °F	100
Minimum evaporator entering air db/wb °F	68/57
Rated air coil entering air db/wb °F	80/67
Maximum evaporator entering air db/wb °F	95/85
Minimum water coil entering fluid temperature °F	50
Water loop typical coil entering fluid range temperature °F	70/90
Maximum water coil entering fluid temperature °F	110
HEATING	
Minimum ambient air temperature °F	40
Maximum ambient air temperature °F	85
Minimum evaporator entering air db °F	50
Rated air coil entering air °F	68
Maximum evaporator entering air db °F	80
Normal water coil entering fluid range °F	25-80*
Minimum water coil entering Fluid °F	20*

* Antifreeze solution is required for fluid temperature at or below 45 Degrees F.

GreenSource i Series Model BP
Residential Geothermal Heat Pumps



Blower Performance CFM Standard Motor - PSC for 012													
Model	Available External Static Pressure (in. wc. Wet coil and filter included)												
	Motor Speed	0.10	0.20	0.30	0.40	0.50	0.60	0.70	0.80	0.90	1.00	1.10	1.20
BP012	High	450	435	415	400	385	360	330	305	-	-	-	-
	Medium	425	405	385	375	360	335	310	-	-	-	-	-
	Low	390	380	365	350	335	315	290	-	-	-	-	-

Blower Performance CFM Standard Motor - Constant Torque ECM for 018-048													
Model	Available External Static Pressure (in. wc. Wet coil and filter included)												
	Motor Speed	0.10	0.20	0.30	0.40	0.50	0.60	0.70	0.80	0.90	1.00	1.10	1.20
BP018	High	808	795	768	736	703	658	576	495	-	-	-	-
	Medium	615	575	540	500	460	420	-	-	-	-	-	-
	Low	540	510	480	445	405	360	-	-	-	-	-	-
BP024	High	975	945	910	880	855	825	790	750	-	-	-	-
	Medium	905	885	855	825	790	755	700	650	-	-	-	-
	Low	725	700	670	640	585	530	-	-	-	-	-	-
BP030	High	1225	1195	1170	1140	1110	1075	1010	940	745	-	-	-
	Medium	1110	1075	1045	1015	985	955	915	880	700	-	-	-
	Low	955	925	890	860	825	790	750	715	685	-	-	-
BP036	High	1440	1420	1400	1380	1345	1315	1240	1165	1005	845	-	-
	Medium	1340	1315	1290	1270	1245	1225	1180	1135	990	845	-	-
	Low	1190	1165	1140	1115	1090	1065	1040	1020	915	810	-	-
BP042	High	1645	1635	1610	1585	1560	1535	1510	1485	1460	1430	-	-
	Medium	1455	1425	1400	1375	1345	1320	1290	1260	1225	1190	-	-
	Low	1220	1190	1160	1130	1100	1070	1015	955	895	830	-	-
BP048	High	1840	1820	1795	1775	1745	1720	1695	1670	1645	1615	-	-
	Medium	1655	1635	1610	1585	1560	1535	1510	1485	1460	1430	-	-
	Low	1455	1425	1400	1375	1345	1320	1290	1260	1225	1190	-	-

Vertical Unit Configuration

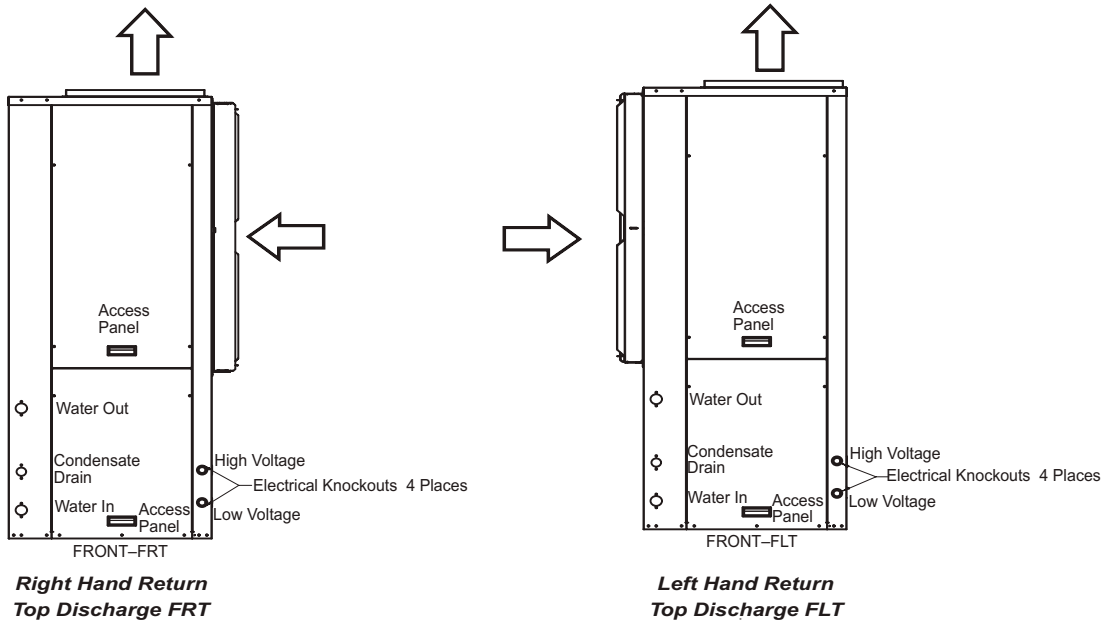

Horizontal Unit Configuration

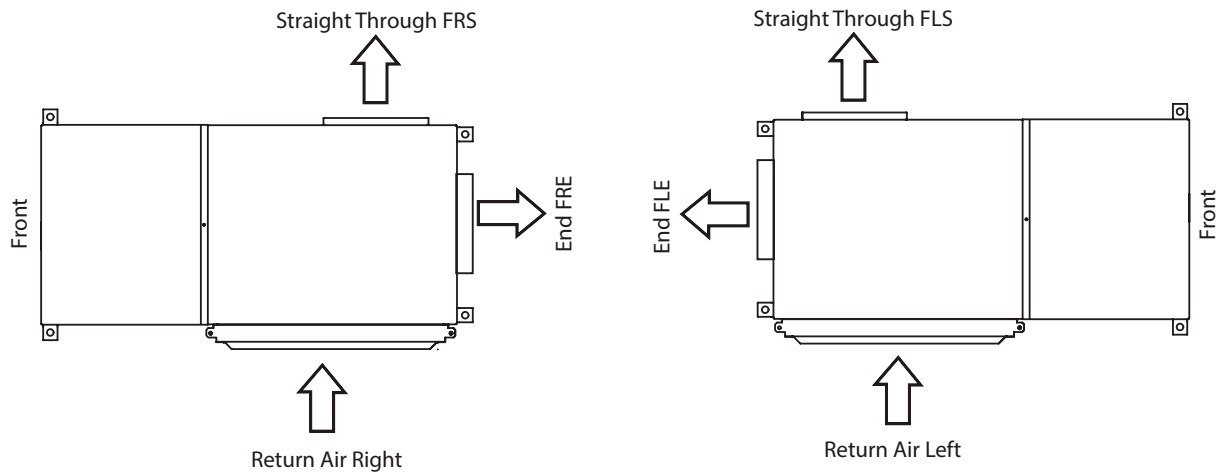

BP-Vertical Dimensions and Connections

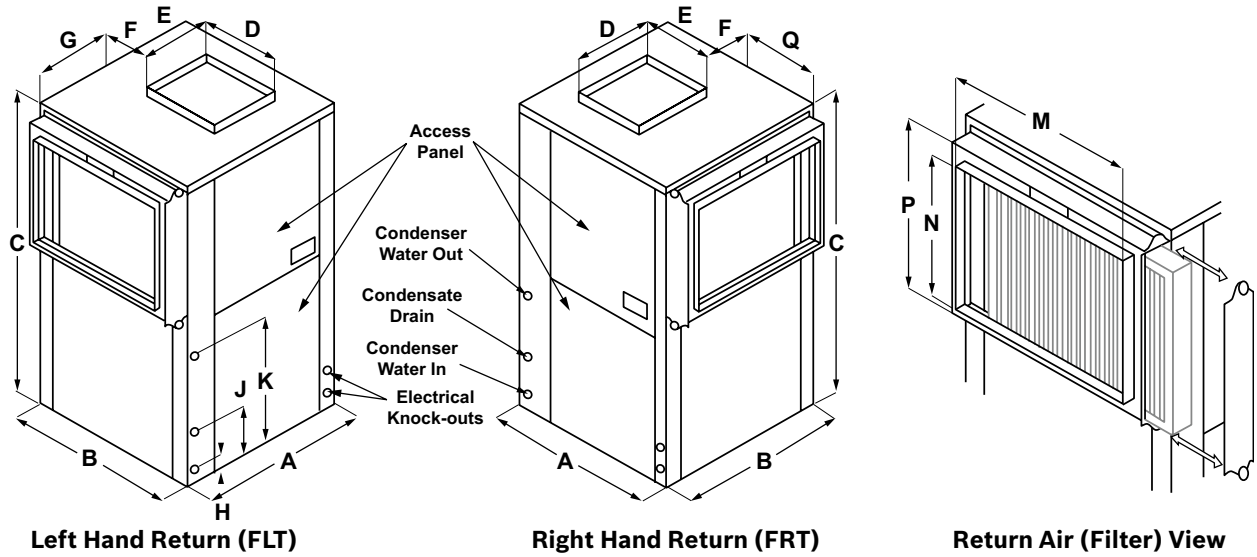

BP-Vertical Dimensions and Connections

Model	A	B	C	D	E	F	G	H	J	K	M	N	P	Q	Condenser Water Connections	Recommended Replacement Normal Filter Size
	Width	Depth	Height	Dis-charge Depth	Dis-charge Width	Cabinet Edge to Dis-charge	Left Side to Dis-charge	Water In	Bottom to Condensate Drain	Water Out	R/A Duct Width	R/A Duct Flange Height	Filter Rack Height	Right Side to Dis-charge		
BP012	21.75	21.75	32.75	11.75	7.75	5.00	8.50	2.62	7.50	12.50	18.00	16.00	18.00	5.32	3/4" FPT	18 x 20 x 2
BP018	21.75	21.75	39.25	13.75	13.75	4.00	6.12	2.25	7.50	12.25	18.00	18.00	20.00	4.00	3/4" FPT	20 x 20 x 2
BP024	21.75	26.25	47.25	13.75	15.75	6.25	4.87	2.50	8.75	15.00	22.00	22.00	24.00	4.00	3/4" FPT	24 x 24 x 2
BP030	24.25	33.50	47.25	15.75	15.75	8.87	7.00	2.50	8.50	14.50	28.00	22.00	24.00	4.00	1" FPT	24 x 30 x 2
BP036	24.25	33.50	47.25	15.75	15.75	8.87	7.00	2.50	8.50	14.50	28.00	22.00	24.00	4.00	1" FPT	24 x 30 x 2
BP042	26.25	33.50	58.25	17.75	17.75	7.87	6.75	3.25	8.50	13.25	28.00	30.00	32.00	4.00	1" FPT	16 x 30 x 2 (2)
BP048	26.25	33.50	58.25	17.75	17.75	7.87	6.75	3.25	8.50	13.25	28.00	30.00	32.00	4.00	1" FPT	16 x 30 x 2 (2)

i All dimensions within +/- 0.125". Specifications subject to change without notice.

BP-Horizontal Dimensions and Connections

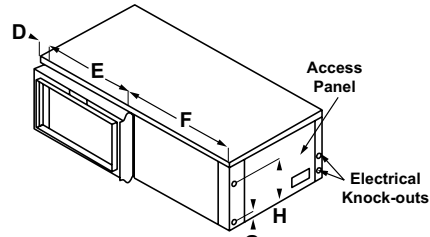

Left Hand Return

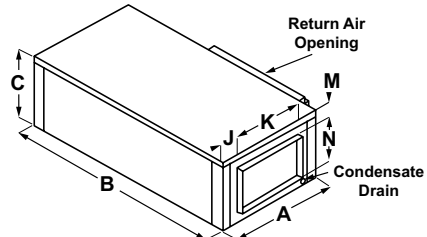

**Left Hand Return
End Blow (FLE)**

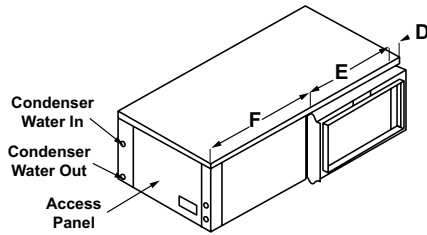

Right Hand Return

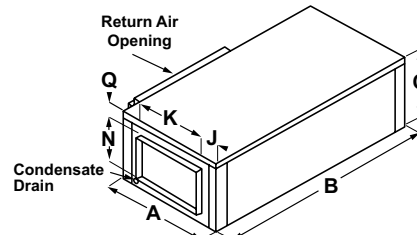

**Right Hand Return
End Blow (FRE)**

BP- Horizontal Dimensions and Connections

Model	A	B	C	D	E	F	G	H	J	K	M	N	P	Q	R	T	Condenser Water Connections	Recommended Replacement Normal Filter Size
	Width	Depth	Height	Cab End to Filter Rack	"R/A Duct Width"	Cab Front to Filter Rack	Water In	Water Out	Side to Dis-charge	Dis-charge Width	Top to Dis-charge (FLE & FRS)	Dis-charge Height	End to Dis-charge	Top to Dis-charge (FRE & FLS)	Filter Rack Height	R/A Duct Flange Height		
BP012	22.25	45.25	19.75	0.62	20.25	24.25	2.50	12.50	3.62	11.75	7.12	7.75	3.62	4.75	18.00	16.00	3/4" FPT	18 x 20 x 2
BP018	22.25	45.25	19.75	1.62	20.25	23.25	2.50	12.50	2.75	13.75	3.12	13.75	2.75	2.87	18.00	16.00	3/4" FPT	18 x 20 x 2
BP024	26.25	54.75	22.00*	1.25	30.25	23.00	2.62	15.12	3.75	13.75	2.12	15.75	3.75	4.25	20.12	18.00	3/4" FPT	20 x 30 x 2
BP030	30.25	68.25	22.00*	2.00	35.00	31.25	2.50	13.25	4.50	15.75	4.00	15.75	4.50	2.25	20.12	18.00	1" FPT	20 x 34.5 x 2
BP036	30.25	68.25	22.00*	2.00	35.00	31.25	2.50	13.25	4.50	15.75	4.00	15.75	4.50	2.25	20.12	18.00	1" FPT	20 x 34.5 x 2
BP042	30.25	79.00	22.00*	0.75	48.25	29.62	2.75	13.25	4.50	17.75	2.25	17.75	4.50	2.12	20.12	18.00	1" FPT	20 x 24 x 2 (2)
BP048	30.25	79.00	22.00*	0.75	48.25	29.62	2.75	13.25	4.50	17.75	2.25	17.75	4.50	2.12	20.12	18.00	1" FPT	20 x 24 x 2 (2)

i All dimensions within +/- 0.125". Specifications subject to change without notice.

BP Service Clearances

**Vertical Unit
Service Clearances**

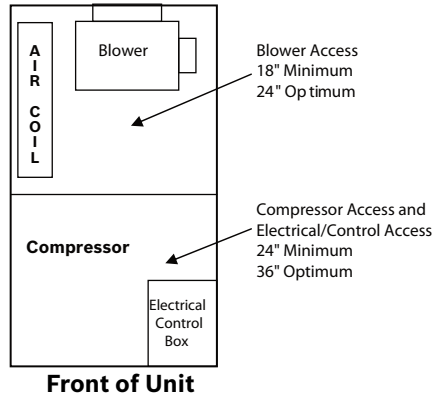

NOTE: The local electric codes may require 36" or more clearance at the electrical control box.

**Horizontal Unit
Service Clearances**

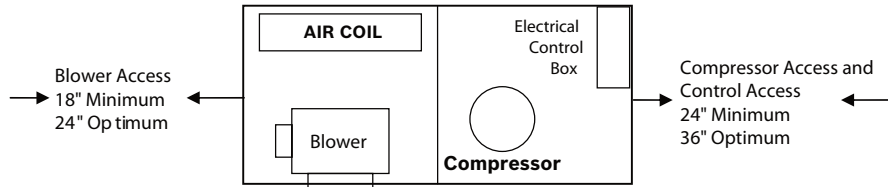

NOTE: The local electric codes may require 36" or more clearance at the electrical control box.

GreenSource i Series Model BP

Residential Geothermal Heat Pumps



Capacity Data BP012 (400 CFM)																
Cooling									Heating							
Entering Water Temp (°F)	Water flow (GPM)	Pressure Drop PSI (FOH)	Entering Air Temp DB/WB (°F)	Total Capacity (MBTUH)	Sensible Capacity (MBTUH)	Heat of Rejection (MBTUH)	Power Input (kW)	EER	Entering Fluid Temp (°F)	Pressure Drop PSI (FOH)	Entering Air Temp (°F)	Total Capacity (MBTUH)	Heat of Absorption (MBTUH)	Power Input (kW)	COP	
50	1.5	0.4	75/63	12.8	9.8	15.1	0.7	19.0	30	0.4	60	8.7	6.4	0.8	3.24	
			80/67	13.7	10.1	16.0	0.7	20.2			70	8.5	6.1	0.8	2.97	
			85/71	14.6	10.3	16.9	0.7	21.6			80	8.4	5.7	0.9	2.75	
	2	0.6	75/63	13.2	9.9	15.4	0.6	20.8		60	9.1	6.7	0.8	3.36		
			80/67	14.1	10.2	16.2	0.6	22.4		70	8.9	6.3	0.8	3.06		
			85/71	15.0	10.4	17.2	0.6	24.1		80	8.7	5.9	0.9	2.81		
	3	1.2	75/63	13.5	10.1	15.6	0.6	22.9		60	9.4	7.0	0.8	3.48		
			80/67	14.5	10.4	16.5	0.6	24.9		70	9.2	6.6	0.9	3.17		
			85/71	15.5	10.6	17.5	0.6	27.2		80	9.0	6.2	0.9	2.89		
60	1.5	0.4	75/63	12.2	9.5	14.8	0.8	16.1	40	0.4	60	10.0	7.6	0.8	3.64	
			80/67	13.0	9.8	15.6	0.8	17.1			70	9.8	7.2	0.9	3.31	
			85/71	13.9	10.0	16.5	0.8	18.2			80	9.6	6.8	0.9	3.02	
	2	0.6	75/63	12.5	9.6	15.0	0.7	17.5		60	10.4	8.0	0.8	3.77		
			80/67	13.4	9.9	15.8	0.7	18.8		70	10.2	7.6	0.9	3.41		
			85/71	14.3	10.2	16.7	0.7	20.0		80	9.9	7.1	0.9	3.1		
	3	1.2	75/63	12.9	9.8	15.2	0.7	19.1		60	10.9	8.4	0.8	3.91		
			80/67	13.8	10.0	16.1	0.7	20.6		70	10.6	7.9	0.9	3.53		
			85/71	14.7	10.4	17.0	0.7	22.3		80	10.3	7.5	0.9	3.19		
70	1.5	0.4	75/63	11.6	9.2	14.4	0.8	13.8	50	0.4	60	11.3	8.8	0.8	4.04	
			80/67	12.4	9.5	15.2	0.8	14.6			70	11.1	8.4	0.9	3.66	
			85/71	13.1	9.8	16.0	0.8	15.5			80	10.9	7.9	1.0	3.33	
	2	0.6	75/63	11.9	9.4	14.6	0.8	14.8		60	11.8	9.3	0.8	4.18		
			80/67	12.7	9.6	15.4	0.8	15.9		70	11.5	8.8	0.9	3.77		
			85/71	13.5	10.0	16.2	0.8	16.9		80	11.3	8.3	1.0	3.42		
	3	1.2	75/63	12.2	9.4	14.8	0.8	16.0		60	12.4	9.9	0.8	4.35		
			80/67	13.0	9.8	15.6	0.8	17.2		70	12.1	9.3	0.9	3.9		
			85/71	14.0	10.0	16.5	0.8	18.6		80	11.8	8.8	1.0	3.53		
80	1.5	0.4	75/63	10.9	9.0	14.0	0.9	11.8	60	0.4	60	12.7	10.2	0.8	4.44	
			80/67	11.7	9.2	14.8	0.9	12.5			70	12.5	9.7	0.9	4	
			85/71	12.4	9.5	15.5	0.9	13.2			80	12.2	9.2	1.0	3.62	
	2	0.6	75/63	11.2	9.0	14.1	0.9	12.7		60	13.3	10.7	0.8	4.6		
			80/67	12.0	9.3	15.0	0.9	13.5		70	13.0	10.2	0.9	4.14		
			85/71	12.8	9.6	15.8	0.9	14.3		80	12.8	9.6	1.0	3.74		
	3	1.2	75/63	11.5	9.2	14.3	0.8	13.6		60	14.0	11.4	0.9	4.8		
			80/67	12.3	9.5	15.2	0.8	14.5		70	13.6	10.8	0.9	4.29		
			85/71	13.2	9.8	16.0	0.8	15.6		80	13.3	10.2	1.0	3.86		
90	1.5	0.3	75/63	10.3	8.7	13.6	1.0	10.2	70	0.4	60	14.2	11.6	0.9	4.85	
			80/67	11.0	9.0	14.3	1.0	10.8			70	13.9	11.0	0.9	4.35	
			85/71	11.7	9.3	15.1	1.0	11.4			80	13.6	10.5	1.0	3.92	
	2	0.6	75/63	10.5	8.8	13.7	1.0	10.8		60	14.9	12.2	0.9	5.04		
			80/67	11.3	9.1	14.5	1.0	11.5		70	14.5	11.6	0.9	4.51		
			85/71	12.0	9.4	15.3	1.0	12.2		80	14.2	11.1	1.0	4.05		
	3	1.1	75/63	10.8	8.9	13.9	0.9	11.5		60	15.7	13.0	0.9	5.26		
			80/67	11.6	9.2	14.7	0.9	12.3		70	15.3	12.4	1.0	4.68		
			85/71	12.4	9.5	15.5	0.9	13.2		80	14.9	11.7	1.0	4.2		
100	1.5	0.3	75/63	9.6	8.4	13.2	1.1	8.8	80	0.4	60	15.6	13.0	0.9	5.26	
			80/67	10.3	8.7	13.9	1.1	9.3			70	15.3	12.4	1.0	4.7	
			85/71	11.0	9.0	14.6	1.1	9.8			80	15.0	11.8	1.0	4.23	
	2	0.6	75/63	9.8	8.5	13.3	1.1	9.3		60	16.4	13.8	0.9	5.47		
			80/67	10.6	8.8	14.1	1.1	9.9		70	16.1	13.1	1.0	4.87		
			85/71	11.3	9.1	14.8	1.1	10.5		80	15.7	12.5	1.1	4.37		
	3	1.1	75/63	10.1	8.6	13.5	1.0	9.8		60	17.4	14.7	0.9	5.71		
			80/67	10.8	9.0	14.2	1.0	10.5		70	16.9	14.0	1.0	5.07		
			85/71	11.6	9.3	15.0	1.0	11.2		80	16.5	13.2	1.1	4.53		
110	1.5	0.2	75/63	8.9	8.1	12.7	1.2	7.5	Extended Range - Anti-freeze required	AHR/ISO 13256-1 certified performance is rated at entering air conditions of 80.6°F DB and 66.2°F WB in cooling and 68°F DB in heating.	Tabulated unit performance does not include fan or pump power corrections required for AHR/ISO standard performance ratings.	Unit performance may be interpolated. Extrapolation is not allowed.	For conditions other than rating conditions provided, consult the BST selection software.	Ratings below 40°F are with a methanol solution.	DISCLAIMER: The performance reported herein is based on testing by FHP. Variations in the installation and operational environment may alter performance. Bosch disclaims all warranties, express and implied, that the performance will be as reported, including the warranty of merchantability and fitness for purpose. In addition, continuous research and development may result in a change to an appliances design and specifications at the time of order, which Bosch may change without notice. Before purchase, confirm the design specifications of the appliance.	
			80/67	9.5	8.4	13.4	1.2	8.0								
	85/71	10.2	8.8	14.2	1.2	8.4										
	2	0.5	75/63	9.2	8.2	12.9	1.1	8.0								
			80/67	9.8	8.5	13.6	1.2	8.5								
	3	1.1	85/71	10.5	8.9	14.4	1.2	9.0								
75/63			9.4	8.3	13.0	1.1	8.4									
80/67	10.1	8.6	13.8	1.1	8.9											
85/71	10.8	9.0	14.5	1.1	9.5											

GreenSource i Series Model BP Residential Geothermal Heat Pumps



Capacity Data BP018 (640 CFM)																	
Cooling									Heating								
Entering Water Temp (°F)	Water flow (GPM)	Pressure Drop PSI (FOH)	Entering Air Temp DB/WB (°F)	Total Capacity (MBTUH)	Sensible Capacity (MBTUH)	Heat of Rejection (MBTUH)	Power Input (kW)	EER	Entering Fluid Temp (°F)	Pressure Drop PSI (FOH)	Entering Air Temp (°F)	Total Capacity (MBTUH)	Heat of Absorption (MBTUH)	Power Input (kW)	COP		
50	2	0.6	75/63	20.1	15.6	23.8	1.1	18.2	30	0.6	60	13.8	10.2	1.2	3.41		
			80/67	21.3	16.1	25.0	1.1	19.5			70	13.5	9.6	1.3	3.15		
			85/71	22.5	16.5	26.3	1.1	20.9			80	13.3	9.1	1.4	2.87		
	3.5	1.6	75/63	21.0	15.9	24.6	1.1	19.7		60	14.8	11.1	1.2	3.53			
			80/67	22.3	16.5	25.9	1.0	21.4		70	14.5	10.5	1.3	3.26			
			85/71	23.8	16.8	27.3	1.0	23.4		80	14.2	9.9	1.4	2.99			
	4.5	2.5	75/63	21.2	16.1	24.9	1.1	20.0		60	15.3	11.5	1.2	3.58			
			80/67	22.6	16.6	26.2	1.0	21.8		70	14.8	10.9	1.3	3.3			
			85/71	24.1	16.9	27.6	1.0	24.0		80	14.6	10.2	1.4	3.03			
	60	2	0.6	75/63	19.2	15.3	23.1	1.2		16.4	40	0.6	60	15.7	11.8	1.3	3.65
				80/67	20.4	15.7	24.3	1.2		17.4			70	15.4	11.3	1.3	3.38
				85/71	21.6	16.0	25.6	1.2		18.4			80	15.2	10.7	1.4	3.1
3.5		1.6	75/63	20.1	15.6	23.8	1.1	18.2	60	17.0		13.1	1.3	3.83			
			80/67	21.4	16.1	25.1	1.1	19.6	70	16.6		12.4	1.4	3.54			
			85/71	22.7	16.4	26.4	1.1	21.3	80	16.3		11.7	1.5	3.25			
4.5		2.5	75/63	20.3	15.7	24.0	1.1	18.7	60	17.5		13.5	1.3	3.91			
			80/67	21.7	16.2	25.3	1.1	20.2	70	17.0		12.8	1.4	3.6			
			85/71	23.1	16.5	26.7	1.0	22.0	80	16.6		12.1	1.5	3.28			
70		2	0.6	75/63	18.3	14.8	22.5	1.3	14.5	50		0.6	60	17.7	13.7	1.3	3.93
				80/67	19.4	15.3	23.7	1.3	15.2				70	17.4	13.0	1.4	3.65
				85/71	20.5	15.8	24.9	1.3	16.0				80	17.0	12.4	1.5	3.34
	3.5	1.6	75/63	19.2	15.2	23.1	1.2	16.3	60		19.2	15.1	1.3	4.19			
			80/67	20.4	15.7	24.3	1.2	17.4	70		18.8	14.3	1.4	3.86			
			85/71	21.7	16.0	25.6	1.2	18.6	80		18.5	13.6	1.5	3.52			
	4.5	2.4	75/63	19.4	15.3	23.3	1.2	16.8	60		19.8	15.7	1.4	4.28			
			80/67	20.6	15.8	24.5	1.1	18.0	70		19.4	14.8	1.4	3.93			
			85/71	22.0	16.2	25.9	1.1	19.5	80		18.9	14.1	1.6	3.58			
	80	2	0.6	75/63	17.4	14.5	22.0	1.4	12.6		60	0.6	60	19.7	15.6	1.4	4.27
				80/67	18.5	15.0	23.1	1.4	13.3				70	19.4	14.8	1.4	3.95
				85/71	19.6	15.4	24.3	1.4	13.9				80	19.1	14.2	1.6	3.6
3.5		1.5	75/63	18.2	14.8	22.5	1.3	14.2	60	21.5		17.3	1.4	4.58			
			80/67	19.3	15.3	23.7	1.3	15.1	70	21.1		16.5	1.5	4.17			
			85/71	20.6	15.8	24.9	1.3	16.0	80	20.7		15.7	1.6	3.8			
4.5		2.4	75/63	18.4	14.9	22.6	1.3	14.7	60	22.2		17.9	1.4	4.7			
			80/67	19.6	15.4	23.8	1.3	15.7	70	21.7		17.1	1.5	4.27			
			85/71	20.9	16.0	25.1	1.2	16.8	80	21.3		16.2	1.6	3.86			
90		2	0.5	75/63	16.5	14.1	21.5	1.5	11.0	70		0.6	60	21.8	17.5	1.4	4.63
				80/67	17.6	14.5	22.6	1.5	11.5				70	21.4	16.8	1.5	4.23
				85/71	18.6	15.1	23.8	1.5	12.0				80	21.1	16.1	1.6	3.85
	3.5	1.4	75/63	17.2	14.5	21.9	1.4	12.3	60		23.9	19.6	1.4	5.02			
			80/67	18.3	15.0	23.1	1.4	13.0	70		23.5	18.8	1.5	4.56			
			85/71	19.5	15.4	24.3	1.4	13.8	80		23.0	17.9	1.6	4.09			
	4.5	2.2	75/63	17.4	14.5	22.0	1.4	12.6	60		24.7	20.4	1.4	5.16			
			80/67	18.6	15.0	23.2	1.4	13.5	70		24.2	19.5	1.5	4.66			
			85/71	19.8	15.4	24.4	1.4	14.3	80		23.7	18.5	1.7	4.18			
	100	2	0.5	75/63	15.6	13.8	21.0	1.6	9.6		80	0.6	60	24.0	19.7	1.4	5.03
				80/67	16.6	14.2	22.1	1.7	10.0				70	23.6	18.9	1.5	4.58
				85/71	17.6	14.8	23.2	1.7	10.5				80	23.2	18.1	1.6	4.12
3.5		1.4	75/63	16.3	14.0	21.3	1.5	10.6	60	26.4		22.1	1.4	5.47			
			80/67	17.4	14.4	22.5	1.6	11.2	70	25.9		21.1	1.5	4.91			
			85/71	18.4	15.1	23.7	1.6	11.8	80	25.4		20.2	1.7	4.4			
4.5		2.2	75/63	16.4	14.1	21.4	1.5	10.8	60	27.3		22.9	1.4	5.62			
			80/67	17.5	14.6	22.6	1.5	11.5	70	26.8		21.9	1.6	5.02			
			85/71	18.7	15.0	23.8	1.5	12.2	80	26.2		20.9	1.7	4.48			
110		2	0.5	75/63	14.7	13.4	20.4	1.8	8.4	Extended Range - Anti-freeze required		0.6	60	24.0	19.7	1.4	5.03
				80/67	15.6	13.9	21.5	1.8	8.7				70	23.6	18.9	1.5	4.58
				85/71	16.5	14.4	22.6	1.8	9.1				80	23.2	18.1	1.6	4.12
	3.5	1.4	75/63	15.2	13.7	20.8	1.7	9.1	60		26.4	22.1	1.4	5.47			
			80/67	16.2	14.2	21.9	1.7	9.6	70		25.9	21.1	1.5	4.91			
			85/71	17.3	14.7	23.1	1.7	10.1	80		25.4	20.2	1.7	4.4			
	4.5	2.2	75/63	15.4	13.8	20.9	1.6	9.4	60		27.3	22.9	1.4	5.62			
			80/67	16.5	13.9	22.0	1.7	9.8	70		26.8	21.9	1.6	5.02			
			85/71	17.6	14.7	23.2	1.7	10.4	80		26.2	20.9	1.7	4.48			

Extended Range - Anti-freeze required
 AHRI/ISO13256-1 certified performance is rated at entering air conditions of 80.6°F DB and 66.2°F WB in cooling and 68°F DB in heating.
 Tabulated unit performance does not include fan or pump power corrections required for AHRI/ISO standard performance ratings.
 Unit performance may be interpolated. Extrapolation is not allowed.
 For conditions other than rating conditions provided, consult the BST selection software.
 Ratings below 40°F are with a methanol solution.

DISCLAIMER: The performance reported herein is based on testing by FHP. Variations in the installation and operational environment may alter performance. Bosch disclaims all warranties, express and implied, that the performance will be as reported, including the warranty of merchantability and fitness for purpose. In addition, continuous research and development may result in a change to an appliances design and specifications at the time of order, which Bosch may change without notice. Before purchase, confirm the design specifications of the appliance.

Bosch Thermotechnology Corp.
 Watertown, MA • Londonderry, NH • Ft. Lauderdale, FL

GreenSource i Series Model BP

Residential Geothermal Heat Pumps



Capacity Data BP024 (850 CFM)																		
Cooling									Heating									
Entering Water Temp (°F)	Water flow (GPM)	Pressure Drop PSI (FOH)	Entering Air Temp DB/WB (°F)	Total Capacity (MBTUH)	Sensible Capacity (MBTUH)	Heat of Rejection (MBTUH)	Power Input (kW)	EER	Entering Fluid Temp (°F)	Pressure Drop PSI (FOH)	Entering Air Temp (°F)	Total Capacity (MBTUH)	Heat of Absorption (MBTUH)	Power Input (kW)	COP			
50	3	0.8	75/63	26.9	20.8	30.9	1.2	22.8	30	0.8	60	18.3	13.5	1.6	3.44			
			80/67	28.6	21.4	32.6	1.2	24.0				70	18.0	12.7	1.7	3.06		
			85/71	30.3	22.1	34.4	1.2	25.2				80	17.7	11.9	1.9	2.72		
	4.5	1.7	75/63	27.6	21.2	31.3	1.1	25.6			60	19.0	14.3	1.6	3.55			
			80/67	29.4	21.8	33.1	1.1	27.3			70	18.6	13.4	1.7	3.16			
			85/71	31.2	22.4	35.0	1.1	28.9			80	18.4	12.5	1.9	2.82			
			75/63	27.9	21.3	31.5	1.0	27.1			60	19.5	14.7	1.6	3.64			
			80/67	29.8	22.0	33.4	1.0	29.1			70	19.1	13.8	1.7	3.23			
			85/71	31.7	22.6	35.3	1.0	31.1			80	18.8	12.8	1.9	2.87			
	6	2.8	75/63	25.6	20.4	30.2	1.3	19.2			60	20.7	15.8	1.6	3.84			
			80/67	27.3	21.0	31.9	1.4	20.2			70	20.4	15.0	1.8	3.41			
			85/71	28.9	21.6	33.6	1.4	21.2			80	20.1	14.1	1.9	3.03			
75/63			26.4	20.6	30.6	1.2	21.2	60	21.7	16.8	1.6	4						
80/67			28.1	21.2	32.4	1.2	22.5	70	21.3	15.9	1.8	3.54						
85/71			29.9	21.9	34.2	1.3	23.8	80	21.0	14.9	2.0	3.14						
60	3	0.8	75/63	26.7	20.7	30.8	1.2	22.3	40	0.8	60	20.7	15.8	1.6	3.84			
			80/67	28.5	21.4	32.6	1.2	23.8				70	20.4	15.0	1.8	3.41		
			85/71	30.3	22.1	34.4	1.2	25.3				80	20.1	14.1	1.9	3.03		
	4.5	1.6	75/63	26.4	20.6	30.6	1.2	21.2			60	21.7	16.8	1.6	4			
			80/67	28.1	21.2	32.4	1.2	22.5			70	21.3	15.9	1.8	3.54			
			85/71	29.9	21.9	34.2	1.3	23.8			80	21.0	14.9	2.0	3.14			
			75/63	26.7	20.7	30.8	1.2	22.3			60	22.3	17.4	1.6	4.08			
			80/67	28.5	21.4	32.6	1.2	23.8			70	21.9	16.4	1.8	3.61			
			85/71	30.3	22.1	34.4	1.2	25.3			80	21.4	15.5	2.0	3.19			
	6	2.7	75/63	24.4	19.8	29.5	1.5	16.3			50	0.8	60	23.3	18.3	1.6	4.24	
			80/67	26.0	20.5	31.1	1.5	17.1						70	23.0	17.4	1.8	3.76
			85/71	27.6	21.1	32.8	1.5	17.9						80	22.7	16.5	2.0	3.34
4.5			1.6	75/63	25.1	20.1	29.9	1.4	17.8	60			24.6	19.5	1.6	4.42		
				80/67	26.8	20.7	31.6	1.4	18.9	70			24.2	18.5	1.8	3.9		
				85/71	28.5	21.3	33.4	1.4	19.9	80			23.8	17.5	2.0	3.47		
6	2.6	75/63	25.4	20.2	30.1	1.4	18.6	60	25.2	20.3			1.6	4.5				
		80/67	27.2	20.8	31.8	1.4	19.8	70	24.8	19.2			1.8	3.98				
		85/71	28.9	21.5	33.6	1.4	21.0	80	24.4	18.0			2.0	3.53				
70	3	0.8	75/63	23.2	19.3	28.8	1.7	13.8	60	0.8			60	26.1	21.0	1.7	4.63	
			80/67	24.6	20.0	30.3	1.7	14.5						70	25.8	20.0	1.8	4.1
			85/71	26.2	20.5	32.0	1.7	15.2						80	25.4	19.0	2.0	3.64
	4.5	1.6	75/63	23.9	19.5	29.1	1.6	15.0			60	27.7	22.4	1.7	4.82			
			80/67	25.4	20.3	30.8	1.6	15.9			70	27.2	21.3	1.9	4.27			
			85/71	27.0	20.9	32.5	1.6	16.8			80	26.8	20.2	2.1	3.77			
			75/63	24.1	19.8	29.3	1.5	15.6			60	28.5	23.2	1.7	4.93			
			80/67	25.8	20.3	31.0	1.6	16.6			70	28.0	22.1	1.9	4.36			
			85/71	27.4	21.1	32.7	1.6	17.6			80	27.5	20.9	2.1	3.85			
	6	2.6	75/63	21.9	18.9	28.1	1.9	11.7			70	0.8	60	29.1	23.7	1.7	5.01	
			80/67	23.4	19.4	29.7	1.9	12.3						70	28.7	22.7	1.9	4.44
			85/71	24.8	20.0	31.2	1.9	12.9						80	28.3	21.6	2.1	3.94
4.5			1.5	75/63	22.5	19.1	28.4	1.8	12.7	60			30.9	25.5	1.7	5.23		
				80/67	24.1	19.7	30.0	1.8	13.4	70			30.4	24.3	1.9	4.63		
				85/71	25.6	20.3	31.7	1.8	14.2	80			29.9	23.1	2.1	4.11		
6	2.5	75/63	22.8	19.2	28.6	1.7	13.1	60	32.0	26.5			1.8	5.35				
		80/67	24.4	19.8	30.2	1.7	13.9	70	31.4	25.2			1.9	4.73				
		85/71	25.9	20.5	31.8	1.8	14.8	80	30.8	24.0			2.2	4.19				
80	3	0.7	75/63	20.7	18.4	27.5	2.1	9.9	80	0.8			60	32.2	26.6	1.8	5.38	
			80/67	22.1	18.9	29.0	2.1	10.5						70	31.7	25.5	2.0	4.77
			85/71	23.5	19.5	30.5	2.1	11.1						80	31.3	24.4	2.2	4.23
	4.5	1.5	75/63	21.2	18.5	27.8	2.0	10.7			60	34.3	28.7	1.8	5.61			
			80/67	22.7	19.1	29.3	2.0	11.3			70	33.7	27.4	2.0	4.95			
			85/71	24.2	19.8	30.9	2.0	12.0			80	33.1	26.1	2.2	4.39			
			75/63	21.4	18.7	27.9	2.0	11.0			60	35.6	29.8	1.8	5.73			
			80/67	22.9	19.2	29.4	2.0	11.7			70	34.8	28.5	2.0	5.05			
			85/71	24.5	20.0	31.0	2.0	12.4			80	34.1	27.1	2.2	4.47			
	6	2.4	75/63	19.4	17.7	27.0	2.3	8.4			110	0.7	60	32.2	26.6	1.8	5.38	
			80/67	20.7	18.5	28.4	2.3	8.8						70	31.7	25.5	2.0	4.77
			85/71	22.0	19.2	29.9	2.4	9.4						80	31.3	24.4	2.2	4.23
4.5			1.5	75/63	19.9	17.9	27.2	2.2	8.9	60			34.3	28.7	1.8	5.61		
				80/67	21.3	18.6	28.7	2.2	9.5	70			33.7	27.4	2.0	4.95		
				85/71	22.7	19.4	30.1	2.2	10.1	80			33.1	26.1	2.2	4.39		
6	2.4	75/63	20.0	18.3	27.2	2.2	9.2	60	35.6	29.8			1.8	5.73				
		80/67	21.5	18.6	28.8	2.2	9.8	70	34.8	28.5			2.0	5.05				
		85/71	23.0	19.5	30.3	2.2	10.4	80	34.1	27.1			2.2	4.47				

 Extended Range - Anti-freeze required

AHRI/ISO13256-1 certified performance is rated at entering air conditions of 80.6°F DB and 66.2°F WB in cooling and 68°F DB in heating.
 Tabulated unit performance does not include fan or pump power corrections required for AHRI/ISO standard performance ratings.
 Unit performance may be interpolated. Extrapolation is not allowed.
 For conditions other than rating conditions provided, consult the BST selection software.
 Ratings below 40°F are with a methanol solution.

DISCLAIMER: The performance reported herein is based on testing by FHP. Variations in the installation and operational environment may alter performance. Bosch disclaims all warranties, express and implied, that the performance will be as reported, including the warranty of merchantability and fitness for purpose. In addition, continuous research and development may result in a change to an appliances design and specifications at the time of order, which Bosch may change without notice. Before purchase, confirm the design specifications of the appliance.

Bosch Thermotechnology Corp.
 Watertown, MA • Londonderry, NH • Ft. Lauderdale, FL

GreenSource i Series Model BP

Residential Geothermal Heat Pumps



Capacity Data BP030 (1040 CFM)																		
Cooling									Heating									
Entering Water Temp (°F)	Water flow (GPM)	Pressure Drop PSI (FOH)	Entering Air Temp DB/WB (°F)	Total Capacity (MBTUH)	Sensible Capacity (MBTUH)	Heat of Rejection (MBTUH)	Power Input (kW)	EER	Entering Fluid Temp (°F)	Pressure Drop PSI (FOH)	Entering Air Temp (°F)	Total Capacity (MBTUH)	Heat of Absorption (MBTUH)	Power Input (kW)	COP			
50	4	0.5	75/63	29.3	23.9	33.8	1.3	22.5	30	0.5	60	19.7	15.0	1.5	3.81			
			80/67	31.1	24.8	35.7	1.3	23.1				70	19.3	14.0	1.7	3.35		
			85/71	32.9	25.5	37.8	1.4	23.6				80	18.9	12.9	1.9	2.96		
	5.5	0.9	75/63	30.1	24.4	34.3	1.2	24.7		60	20.4	15.7	1.5	3.94				
			80/67	32.0	25.0	36.3	1.3	25.5		70	19.9	14.5	1.7	3.46				
			85/71	33.9	25.7	38.4	1.3	26.1		80	19.4	13.5	1.9	3.03				
	7.5	1.5	75/63	30.6	24.6	34.6	1.2	26.4		60	21.0	16.1	1.5	4.05				
			80/67	32.6	25.2	36.7	1.2	27.4		70	20.4	15.0	1.7	3.54				
			85/71	34.6	25.9	38.9	1.2	28.1		80	20.0	13.9	1.9	3.13				
	60	4	0.5	75/63	28.0	23.5	33.0	1.5		19.2	40	0.5	60	22.3	17.5	1.5	4.3	
				80/67	29.7	24.1	34.8	1.5		19.8				70	21.8	16.4	1.7	3.78
				85/71	31.4	25.0	36.8	1.6		20.3				80	21.4	15.5	1.9	3.33
5.5		0.9	75/63	28.7	23.8	33.4	1.4	20.9	60	23.1		18.4	1.5	4.47				
			80/67	30.5	24.6	35.3	1.4	21.6	70	22.6		17.2	1.7	3.92				
			85/71	32.4	25.1	37.4	1.5	22.2	80	22.5		16.1	1.9	3.5				
7.5		1.5	75/63	29.2	24.0	33.7	1.3	22.2	60	23.8		19.2	1.5	4.59				
			80/67	31.1	24.7	35.7	1.3	23.1	70	23.3		17.8	1.7	4.03				
			85/71	33.1	25.4	37.9	1.4	23.8	80	22.8		16.4	1.9	3.54				
70		4	0.5	75/63	26.6	22.9	32.1	1.6	16.4	50		0.5	60	25.0	20.2	1.5	4.81	
				80/67	28.3	23.8	33.9	1.7	17.0					70	24.5	19.2	1.7	4.22
				85/71	30.0	24.5	35.9	1.7	17.5					80	24.1	18.1	1.9	3.72
	5.5	0.8	75/63	27.3	23.1	32.6	1.5	17.8	60		26.1	21.2	1.5	5.01				
			80/67	29.0	24.0	34.4	1.6	18.5	70		25.5	20.0	1.7	4.39				
			85/71	30.8	24.8	36.4	1.6	19.0	80		25.0	19.0	1.9	3.85				
	7.5	1.4	75/63	27.8	23.4	32.8	1.5	18.8	60		27.0	22.1	1.5	5.16				
			80/67	29.6	24.2	34.8	1.5	19.6	70		26.5	21.0	1.7	4.54				
			85/71	31.4	25.0	36.8	1.6	20.3	80		25.8	19.6	1.9	3.96				
	80	4	0.5	75/63	25.3	22.3	31.4	1.8	14.0		60	0.5	60	28.0	23.1	1.5	5.31	
				80/67	26.8	23.3	33.1	1.8	14.5					70	27.4	22.0	1.7	4.66
				85/71	28.5	24.0	35.0	1.9	15.0					80	27.0	20.9	1.9	4.11
5.5		0.8	75/63	25.9	22.6	31.7	1.7	15.1	60	29.3		24.4	1.6	5.51				
			80/67	27.6	23.5	33.6	1.8	15.8	70	28.6		23.1	1.7	4.82				
			85/71	29.3	24.1	35.5	1.8	16.3	80	28.2		22.0	1.9	4.26				
7.5		1.4	75/63	26.3	22.9	32.0	1.7	15.9	60	30.4		25.5	1.6	5.66				
			80/67	28.1	23.5	33.9	1.7	16.7	70	29.7		24.1	1.8	4.96				
			85/71	29.9	24.3	35.8	1.7	17.3	80	29.1		22.9	1.9	4.37				
90		4	0.5	75/63	23.8	21.9	30.6	2.0	11.9	70		0.5	60	31.2	26.2	1.6	5.75	
				80/67	25.4	22.7	32.3	2.0	12.4					70	30.6	25.0	1.8	5.07
				85/71	27.0	23.5	34.1	2.1	12.9					80	30.1	23.9	2.0	4.48
	5.5	0.8	75/63	24.4	22.1	30.9	1.9	12.8	60		32.8	27.7	1.6	5.93				
			80/67	26.1	23.0	32.7	1.9	13.4	70		32.1	26.4	1.8	5.23				
			85/71	27.8	23.7	34.5	2.0	13.9	80		31.5	25.2	2.0	4.63				
	7.5	1.4	75/63	24.9	22.3	31.1	1.9	13.5	60		34.1	29.1	1.6	6.06				
			80/67	26.6	23.1	33.0	1.9	14.1	70		33.4	27.6	1.8	5.35				
			85/71	28.3	23.9	34.9	1.9	14.7	80		32.7	26.2	2.0	4.74				
	100	4	0.5	75/63	22.4	21.3	29.9	2.2	10.1		80	0.5	60	34.6	29.4	1.7	6.11	
				80/67	24.0	22.1	31.6	2.3	10.6					70	34.0	28.2	1.8	5.4
				85/71	25.5	23.0	33.4	2.3	11.1					80	33.4	27.0	2.0	4.8
5.5		0.8	75/63	23.0	21.4	30.2	2.1	10.8	60	36.6		31.2	1.7	6.25				
			80/67	24.6	22.4	31.9	2.2	11.4	70	35.9		29.9	1.9	5.54				
			85/71	26.2	23.3	33.7	2.2	11.9	80	35.2		28.5	2.1	4.92				
7.5		1.4	75/63	23.4	21.6	30.4	2.1	11.3	60	38.2		32.8	1.8	6.33				
			80/67	25.0	22.5	32.1	2.1	11.9	70	37.3		31.4	1.9	5.62				
			85/71	26.7	23.4	34.0	2.1	12.5	80	36.6		29.8	2.1	5				
110		4	0.4	75/63	21.0	20.6	29.3	2.5	8.5	Extended Range - Anti-freeze required								
				80/67	22.5	21.7	30.9	2.5	9.0	AHRI/ISO13256-1 certified performance is rated at entering air conditions of 80.6°F DB and 66.2°F WB in cooling and 68°F DB in heating.								
		5.5	0.8	75/63	24.0	22.4	32.7	2.5	9.5	Tabulated unit performance does not include fan or pump power corrections required for AHRI/ISO standard performance ratings.								
	80/67			23.1	21.8	31.2	2.4	9.6	Unit performance may be interpolated. Extrapolation is not allowed.									
	7.5	1.3	75/63	21.9	21.1	29.7	2.3	9.5	For conditions other than rating conditions provided, consult the BST selection software.									
			80/67	23.5	21.8	31.4	2.3	10.1	Ratings below 40°F are with a methanol solution.									
			85/71	25.2	22.8	33.2	2.4	10.6	DISCLAIMER: The performance reported herein is based on testing by FHP. Variations in the installation and operational environment may alter performance. Bosch disclaims all warranties, express and implied, that the performance will be as reported, including the warranty of merchantability and fitness for purpose. In addition, continuous research and development may result in a change to an appliances design and specifications at the time of order, which Bosch may change without notice. Before purchase, confirm the design specifications of the appliance.									

GreenSource i Series Model BP

Residential Geothermal Heat Pumps



Capacity Data BP036 (1100 CFM)																		
Cooling										Heating								
Entering Water Temp (°F)	Water flow (GPM)	Pressure Drop PSI (FOH)	Entering Air Temp DB/WB (°F)	Total Capacity (MBTUH)	Sensible Capacity (MBTUH)	Heat of Rejection (MBTUH)	Power Input (kW)	EER	Entering Fluid Temp (°F)	Pressure Drop PSI (FOH)	Entering Air Temp (°F)	Total Capacity (MBTUH)	Heat of Absorption (MBTUH)	Power Input (kW)	COP			
50	4.5	0.6	75/63	35.9	27.4	41.6	1.7	21.4	30	0.7		60	24.8	18.3	2.0	3.71		
			80/67	38.1	28.2	43.9	1.7	22.5				70	24.2	17.2	2.2	3.29		
			85/71	40.5	29.0	46.4	1.7	23.6				80	24.3	17.0	2.4	2.97		
	7	1.4	75/63	37.1	28.0	42.4	1.5	24.2		60	25.8	19.6	2.0	3.82				
			80/67	39.5	28.8	44.8	1.5	25.5		70	25.3	18.4	2.2	3.4				
			85/71	42.1	29.4	47.5	1.6	27.0		80	25.4	17.9	2.4	3.08				
	9	2.1	75/63	37.6	28.3	42.7	1.5	25.6		60	26.5	19.8	2.0	3.91				
			80/67	40.1	29.1	45.2	1.5	27.0		70	26.4	19.3	2.2	3.52				
			85/71	42.8	29.6	47.9	1.5	28.7		80	26.4	18.6	2.4	3.17				
	60	4.5	0.6	75/63	34.2	26.8	40.6	1.9		18.5	40	0.6		60	27.8	21.4	2.0	4.06
				80/67	36.4	27.6	42.8	1.9		19.4				70	27.4	20.3	2.2	3.63
				85/71	38.8	28.2	45.3	1.9		20.3				80	28.3	19.3	2.5	3.36
7		1.3	75/63	35.5	27.3	41.3	1.7	20.7	60	30.0		23.6	2.0	4.3				
			80/67	37.8	28.1	43.7	1.7	21.8	70	28.8		21.6	2.2	3.76				
			85/71	40.2	28.9	46.3	1.7	23.0	80	28.2		20.6	2.5	3.34				
9		2.1	75/63	36.0	27.5	41.6	1.7	21.7	60	30.2		23.8	2.0	4.33				
			80/67	38.4	28.2	44.1	1.7	23.0	70	29.9		23.6	2.3	3.87				
			85/71	40.9	29.0	46.7	1.7	24.3	80	30.2		21.6	2.5	3.54				
70		4.5	0.6	75/63	32.6	26.1	39.5	2.0	15.9	50		0.6		60	31.3	24.8	2.1	4.45
				80/67	34.7	26.9	41.7	2.1	16.7					70	30.8	23.7	2.3	3.96
				85/71	36.8	27.8	44.0	2.1	17.5					80	31.1	23.1	2.5	3.62
	7	1.3	75/63	33.8	26.5	40.3	1.9	17.7	60		34.0	27.7	2.1	4.74				
			80/67	36.1	27.3	42.6	1.9	18.7	70		32.5	25.7	2.3	4.13				
			85/71	38.3	28.4	45.0	1.9	19.7	80		32.2	23.0	2.5	3.72				
	9	2.0	75/63	34.3	26.7	40.6	1.9	18.5	60		34.8	29.1	2.1	4.82				
			80/67	36.6	27.5	43.0	1.9	19.6	70		33.6	25.0	2.3	4.26				
			85/71	39.1	28.3	45.5	1.9	20.8	80		33.5	25.4	2.6	3.84				
	80	4.5	0.6	75/63	31.0	25.5	38.6	2.3	13.7		60	0.6		60	35.1	28.4	2.1	4.85
				80/67	33.0	26.4	40.7	2.3	14.4					70	34.6	27.0	2.3	4.35
				85/71	35.2	27.0	43.0	2.3	15.2					80	34.1	25.8	2.6	3.89
7		1.3	75/63	32.2	25.9	39.3	2.1	15.2	60	37.6		30.7	2.2	5.11				
			80/67	34.3	26.7	41.5	2.1	16.1	70	36.8		29.2	2.4	4.55				
			85/71	36.6	27.5	43.9	2.2	17.0	80	36.3		26.7	2.6	4.08				
9		2.0	75/63	32.5	26.1	39.5	2.1	15.8	60	38.6		32.3	2.2	5.2				
			80/67	34.7	26.9	41.8	2.1	16.8	70	37.8		30.5	2.4	4.64				
			85/71	37.0	27.8	44.2	2.1	17.8	80	37.0		29.2	2.6	4.13				
90		4.5	0.6	75/63	29.3	24.8	37.7	2.5	11.7	70		0.6		60	39.0	32.2	2.2	5.25
				80/67	31.2	25.7	39.7	2.5	12.4					70	38.5	30.7	2.4	4.71
				85/71	33.3	26.5	41.9	2.5	13.1					80	37.7	29.8	2.6	4.19
	7	1.3	75/63	30.3	25.3	38.2	2.3	12.9	60		42.0	35.0	2.2	5.53				
			80/67	32.5	26.0	40.4	2.4	13.7	70		41.3	33.2	2.4	4.95				
			85/71	34.6	26.9	42.7	2.4	14.5	80		40.3	31.9	2.7	4.4				
	9	2.0	75/63	30.9	25.4	38.6	2.3	13.5	60		43.4	36.4	2.2	5.65				
			80/67	32.9	26.3	40.7	2.3	14.3	70		42.5	34.6	2.5	5.04				
			85/71	35.2	27.0	43.0	2.3	15.2	80		41.7	32.9	2.7	4.51				
	100	4.5	0.6	75/63	27.6	24.2	36.8	2.8	10.0		80	0.6		60	43.2	36.2	2.2	5.83
				80/67	29.5	25.1	38.8	2.8	10.6					70	42.5	34.6	2.5	5.05
				85/71	31.4	26.0	40.8	2.8	11.2					80	41.9	33.2	2.7	4.52
7		1.2	75/63	28.6	24.6	37.3	2.6	11.0	60	46.6		39.5	2.3	5.92				
			80/67	30.6	25.5	39.4	2.6	11.7	70	45.8		37.4	2.5	5.31				
			85/71	33.0	25.5	41.7	2.6	12.6	80	45.0		35.7	2.8	4.75				
9		1.9	75/63	29.0	24.6	37.5	2.5	11.5	60	48.3		41.1	2.3	6.04				
			80/67	31.0	25.6	39.6	2.5	12.2	70	47.5		39.2	2.6	5.42				
			85/71	33.3	26.3	41.9	2.6	13.0	80	46.7		37.7	2.8	4.86				
110		4.5	0.6	75/63	25.9	23.5	36.1	3.0	8.5	Extended Range - Anti-freeze required				60	46.7	37.7	2.8	4.86
				80/67	27.7	24.4	38.0	3.1	9.0									
				85/71	29.5	25.3	40.0	3.1	9.6									
	7	1.2	75/63	26.9	23.9	36.5	2.9	9.3										
			80/67	28.8	24.8	38.5	2.9	10.0										
			85/71	30.8	25.5	40.6	2.9	10.6										
9	1.9	75/63	27.3	24.1	36.7	2.8	9.7											
		80/67	29.2	24.7	38.7	2.8	10.4											
		85/71	31.2	25.6	40.7	2.8	11.0											

Extended Range - Anti-freeze required
 AHRI/ISO13256-1 certified performance is rated at entering air conditions of 80.6°F DB and 66.2°F WB in cooling and 68°F DB in heating.
 Tabulated unit performance does not include fan or pump power corrections required for AHRI/ISO standard performance ratings.
 Unit performance may be interpolated. Extrapolation is not allowed.
 For conditions other than rating conditions provided, consult the BST selection software.
 Ratings below 40°F are with a methanol solution.

DISCLAIMER: The performance reported herein is based on testing by FHP. Variations in the installation and operational environment may alter performance. Bosch disclaims all warranties, express and implied, that the performance will be as reported, including the warranty of merchantability and fitness for purpose. In addition, continuous research and development may result in a change to an appliances design and specifications at the time of order, which Bosch may change without notice. Before purchase, confirm the design specifications of the appliance.

Bosch Thermotechnology Corp.

Watertown, MA • Londonderry, NH • Ft. Lauderdale, FL

GreenSource i Series Model BP

Residential Geothermal Heat Pumps



Capacity Data BP042 (1400 CFM)																	
Cooling									Heating								
Entering Water Temp (°F)	Water flow (GPM)	Pressure Drop PSI (FOH)	Entering Air Temp DB/WB (°F)	Total Capacity (MBTUH)	Sensible Capacity (MBTUH)	Heat of Rejection (MBTUH)	Power Input (kW)	EER	Entering Fluid Temp (°F)	Pressure Drop PSI (FOH)	Entering Air Temp (°F)	Total Capacity (MBTUH)	Heat of Absorption (MBTUH)	Power Input (kW)	COP		
50	5	0.8	75/63	41.1	33.1	48.0	2.0	20.6	30	0.8	60	26.9	20.3	2.1	3.8		
			80/67	43.7	34.1	50.7	2.0	21.6			70	26.3	18.6	2.3	3.35		
			85/71	46.4	35.1	53.5	2.1	22.6			80	26.2	18.7	2.6	2.99		
	8	1.7	75/63	42.9	33.8	49.1	1.8	23.8		60	29.0	23.2	2.1	4.04			
			80/67	45.8	34.7	52.0	1.8	25.3		70	27.6	20.1	2.3	3.48			
			85/71	48.6	35.6	54.9	1.8	26.7		80	27.7	18.9	2.6	3.14			
	10	2.6	75/63	43.5	34.1	49.5	1.7	25.1		60	29.6	24.4	2.1	4.12			
			80/67	46.4	35.0	52.4	1.7	26.8		70	29.1	22.2	2.3	3.65			
			85/71	49.4	35.9	55.4	1.7	28.4		80	28.2	19.9	2.6	3.18			
	60	5	0.7	75/63	39.2	32.2	46.8	2.2		17.6	40	0.8	60	30.8	23.6	2.1	4.26
				80/67	41.7	33.3	49.4	2.3		18.5			70	29.9	22.1	2.4	3.73
				85/71	44.2	34.3	52.1	2.3		19.3			80	30.2	22.4	2.6	3.38
8		1.7	75/63	40.9	32.8	47.8	2.0	20.1	60	32.9		28.0	2.2	4.48			
			80/67	43.6	33.8	50.6	2.0	21.3	70	31.5		24.1	2.4	3.89			
			85/71	46.4	34.8	53.4	2.1	22.5	80	31.0		23.7	2.6	3.45			
10		2.5	75/63	41.5	33.1	48.2	2.0	21.1	60	33.4		26.2	2.2	4.55			
			80/67	44.3	34.1	51.0	2.0	22.4	70	32.1		24.7	2.4	3.95			
			85/71	47.0	35.3	53.9	2.0	23.7	80	31.4		23.0	2.6	3.48			
70		5	0.7	75/63	37.2	31.5	45.6	2.5	15.1	50		0.8	60	34.3	27.4	2.2	4.64
				80/67	39.6	32.6	48.1	2.5	15.9				70	33.6	26.1	2.4	4.09
				85/71	42.2	33.4	50.8	2.5	16.6				80	33.0	24.4	2.7	3.63
	8	1.6	75/63	38.9	32.0	46.6	2.3	17.1	60		36.7	29.6	2.2	4.89			
			80/67	41.4	33.1	49.2	2.3	18.1	70		35.8	28.1	2.4	4.31			
			85/71	44.1	34.0	52.0	2.3	19.1	80		35.1	28.1	2.7	3.8			
	10	2.4	75/63	39.4	32.2	46.9	2.2	17.9	60		37.6	30.5	2.2	4.98			
			80/67	42.1	33.3	49.6	2.2	19.0	70		36.6	28.6	2.4	4.38			
			85/71	44.8	34.3	52.4	2.2	20.1	80		36.3	28.4	2.7	3.91			
	80	5	0.7	75/63	35.2	30.7	44.4	2.7	12.9		60	0.7	60	38.3	31.6	2.2	5.04
				80/67	37.6	31.6	46.9	2.8	13.6				70	37.6	30.0	2.5	4.47
				85/71	40.0	32.6	49.5	2.8	14.3				80	37.0	28.4	2.7	3.98
8		1.6	75/63	36.7	31.3	45.3	2.5	14.5	60	41.2		34.4	2.3	5.32			
			80/67	39.3	32.2	47.9	2.5	15.4	70	40.3		32.6	2.5	4.72			
			85/71	41.8	33.5	50.5	2.6	16.3	80	39.6		30.2	2.8	4.2			
10		2.4	75/63	37.3	31.5	45.6	2.5	15.2	60	42.3		35.5	2.3	5.43			
			80/67	39.9	32.4	48.3	2.5	16.1	70	41.4		33.5	2.5	4.82			
			85/71	42.5	33.7	50.9	2.5	17.1	80	40.8		32.5	2.8	4.3			
90		5	0.7	75/63	33.2	29.8	43.4	3.0	11.0	70		0.7	60	42.7	35.5	2.3	5.47
				80/67	35.4	31.1	45.7	3.1	11.6				70	41.9	34.1	2.5	4.86
				85/71	37.7	32.2	48.2	3.1	12.2				80	41.2	32.4	2.8	4.33
	8	1.6	75/63	34.7	30.3	44.2	2.8	12.4	60		46.2	38.8	2.3	5.8			
			80/67	37.0	31.7	46.6	2.8	13.1	70		45.1	37.2	2.6	5.13			
			85/71	39.5	32.7	49.2	2.8	13.9	80		44.3	35.1	2.8	4.57			
	10	2.3	75/63	35.2	30.7	44.4	2.7	12.8	60		47.6	40.1	2.4	5.92			
			80/67	37.6	31.8	46.9	2.8	13.7	70		46.4	38.5	2.6	5.24			
			85/71	40.2	32.7	49.6	2.8	14.5	80		45.4	36.6	2.9	4.65			
	100	5	0.7	75/63	31.3	29.0	42.5	3.3	9.4		80	0.7	60	47.2	40.2	2.4	5.87
				80/67	33.4	30.3	44.8	3.4	9.9				70	46.4	38.4	2.6	5.24
				85/71	35.6	31.4	47.1	3.4	10.5				80	45.6	36.7	2.9	4.67
8		1.5	75/63	32.6	29.7	43.1	3.1	10.5	60	51.3		44.1	2.4	6.21			
			80/67	34.8	30.9	45.5	3.1	11.1	70	50.2		42.1	2.7	5.52			
			85/71	37.2	32.1	47.9	3.2	11.8	80	49.2		40.2	2.9	4.92			
10		2.3	75/63	33.0	29.9	43.3	3.0	10.8	60	52.9		45.7	2.4	6.34			
			80/67	35.3	31.1	45.7	3.1	11.5	70	51.7		43.5	2.7	5.63			
			85/71	37.8	32.1	48.3	3.1	12.3	80	50.6		41.2	3.0	5.01			
110		5	0.7	75/63	29.3	28.4	41.7	3.7	7.9	Extended Range - Anti-freeze required		0.7	60	47.2	40.2	2.4	5.87
				80/67	31.3	29.6	43.9	3.7	8.4				70	46.4	38.4	2.6	5.24
				85/71	33.3	31.1	46.1	3.8	8.9				80	45.6	36.7	2.9	4.67
	8	1.5	75/63	30.5	28.8	42.2	3.5	8.8	60		51.3	44.1	2.4	6.21			
			80/67	32.7	30.1	44.5	3.5	9.4	70		50.2	42.1	2.7	5.52			
			85/71	35.0	31.0	46.8	3.5	10.0	80		49.2	40.2	2.9	4.92			
	10	2.2	75/63	31.0	28.9	42.4	3.4	9.2	60		52.9	45.7	2.4	6.34			
			80/67	33.3	30.0	44.7	3.4	9.8	70		51.7	43.5	2.7	5.63			
			85/71	35.5	31.3	47.1	3.4	10.4	80		50.6	41.2	3.0	5.01			

Extended Range - Anti-freeze required

AHRI/ISO13256-1 certified performance is rated at entering air conditions of 80.6°F DB and 66.2°F WB in cooling and 68°F DB in heating.

Tabulated unit performance does not include fan or pump power corrections required for AHRI/ISO standard performance ratings.

Unit performance may be interpolated. Extrapolation is not allowed.

For conditions other than rating conditions provided, consult the BST selection software.

Ratings below 40°F are with a methanol solution.

DISCLAIMER: The performance reported herein is based on testing by FHP. Variations in the installation and operational environment may alter performance. Bosch disclaims all warranties, express and implied, that the performance will be as reported, including the warranty of merchantability and fitness for purpose. In addition, continuous research and development may result in a change to an appliances design and specifications at the time of order, which Bosch may change without notice. Before purchase, confirm the design specifications of the appliance.

GreenSource i Series Model BP

Residential Geothermal Heat Pumps



BOSCH

Capacity Data BP048 (1670 CFM)																	
Cooling									Heating								
Entering Water Temp (°F)	Water flow (GPM)	Pressure Drop PSI (FOH)	Entering Air Temp DB/WB (°F)	Total Capacity (MBTUH)	Sensible Capacity (MBTUH)	Heat of Rejection (MBTUH)	Power Input (kW)	EER	Entering Fluid Temp (°F)	Pressure Drop PSI (FOH)	Entering Air Temp (°F)	Total Capacity (MBTUH)	Heat of Absorption (MBTUH)	Power Input (kW)	COP		
50	6	1.0	75/63	48.1	38.9	56.5	2.5	19.6	30	1.1	60	33.3	25.0	2.6	3.72		
			80/67	51.3	39.9	59.7	2.5	20.9			70	32.6	23.7	2.9	3.32		
			85/71	54.5	41.0	62.9	2.4	22.3			80	32.3	21.9	3.2	2.99		
	9	2.1	75/63	49.8	39.6	57.7	2.3	21.8		60	35.0	26.7	2.7	3.86			
			80/67	53.2	40.6	61.0	2.3	23.5		70	34.2	24.9	2.9	3.45			
			85/71	56.6	41.7	64.3	2.2	25.4		80	33.6	23.3	3.2	3.09			
	12	3.5	75/63	50.7	39.9	58.3	2.2	23.1		60	35.8	27.7	2.7	3.94			
			80/67	54.2	41.0	61.6	2.2	25.0		70	34.9	25.8	2.9	3.51			
			85/71	57.7	42.2	65.1	2.1	27.2		80	34.4	24.0	3.2	3.14			
	60	6	1.0	75/63	46.0	37.8	55.2	2.7		16.9	40	1.1	60	37.4	29.1	2.7	4.07
				80/67	48.9	39.2	58.2	2.7		18.0			70	36.8	27.6	2.9	3.65
				85/71	51.9	40.4	61.3	2.7		19.1			80	36.2	26.1	3.2	3.27
9		2.1	75/63	47.6	38.4	56.2	2.5	18.9	60	39.4		31.2	2.7	4.24			
			80/67	50.7	39.9	59.3	2.5	20.2	70	38.7		29.4	3.0	3.8			
			85/71	54.0	41.2	62.6	2.5	21.7	80	38.2		27.5	3.3	3.41			
12		3.4	75/63	48.5	38.8	56.8	2.4	20.0	60	40.7		32.3	2.7	4.35			
			80/67	51.7	40.3	60.0	2.4	21.5	70	39.7		30.5	3.0	3.87			
			85/71	55.2	41.2	63.4	2.4	23.3	80	39.0		28.8	3.3	3.45			
70		6	1.0	75/63	43.8	36.9	53.9	3.0	14.5	50		1.0	60	42.1	33.4	2.8	4.46
				80/67	46.5	38.4	56.8	3.0	15.4				70	41.3	31.8	3.0	3.98
				85/71	49.6	39.3	59.8	3.0	16.4				80	40.7	30.3	3.3	3.57
	9	2.0	75/63	45.3	37.7	54.8	2.8	16.2	60		44.6	35.8	2.8	4.66			
			80/67	48.4	38.8	57.9	2.8	17.3	70		43.7	34.2	3.1	4.16			
			85/71	51.4	40.2	61.0	2.8	18.6	80		43.0	32.5	3.4	3.72			
	12	3.4	75/63	46.2	37.8	55.3	2.7	17.1	60		46.1	37.4	2.8	4.77			
			80/67	49.3	39.1	58.4	2.7	18.4	70		45.1	35.6	3.1	4.27			
			85/71	52.5	40.6	61.6	2.7	19.8	80		44.3	33.7	3.4	3.81			
	80	6	1.0	75/63	41.4	36.2	52.7	3.3	12.4		60	1.0	60	46.9	38.2	2.8	4.84
				80/67	44.2	37.5	55.5	3.3	13.2				70	46.2	36.5	3.1	4.34
				85/71	47.1	38.4	58.4	3.3	14.1				80	45.6	34.8	3.4	3.89
9		2.0	75/63	42.9	36.8	53.5	3.1	13.8	60	50.1		41.1	2.9	5.1			
			80/67	45.8	38.1	56.4	3.1	14.8	70	49.2		39.2	3.2	4.56			
			85/71	48.9	39.3	59.4	3.1	15.8	80	48.3		37.5	3.5	4.07			
12		3.3	75/63	43.7	37.1	53.9	3.0	14.6	60	51.9		43.0	2.9	5.24			
			80/67	46.8	38.2	57.0	3.0	15.7	70	50.9		41.0	3.2	4.68			
			85/71	50.0	39.4	60.1	3.0	16.8	80	49.9		39.0	3.5	4.17			
90		6	1.0	75/63	39.1	35.2	51.6	3.7	10.6	70		1.0	60	52.2	43.2	2.9	5.26
				80/67	41.8	36.5	54.3	3.7	11.3				70	51.4	41.4	3.2	4.71
				85/71	44.4	38.0	57.0	3.7	12.0				80	50.6	39.6	3.5	4.22
	9	2.0	75/63	40.5	35.9	52.2	3.5	11.7	60		56.0	46.7	2.9	5.56			
			80/67	43.3	37.3	55.0	3.5	12.5	70		54.8	44.8	3.2	4.96			
			85/71	46.1	38.7	57.9	3.4	13.4	80		53.8	42.7	3.6	4.43			
	12	3.2	75/63	41.3	36.1	52.6	3.3	12.4	60		58.1	49.0	3.0	5.73			
			80/67	44.3	37.2	55.6	3.3	13.3	70		56.9	46.8	3.3	5.1			
			85/71	47.3	38.5	58.5	3.3	14.3	80		55.7	44.6	3.6	4.55			
	100	6	0.9	75/63	36.8	34.2	50.5	4.1	9.1		80	1.0	60	57.7	48.5	3.0	5.7
				80/67	39.3	35.7	53.1	4.1	9.6				70	56.7	46.6	3.3	5.09
				85/71	41.8	37.2	55.7	4.1	10.2				80	55.8	44.6	3.6	4.55
9		1.9	75/63	38.1	34.9	51.1	3.8	9.9	60	61.9		52.7	3.0	6.04			
			80/67	40.7	36.4	53.8	3.8	10.6	70	60.7		50.5	3.3	5.38			
			85/71	43.5	37.7	56.5	3.8	11.4	80	59.6		48.2	3.6	4.79			
12		3.2	75/63	38.8	35.3	51.4	3.7	10.4	60	64.5		55.0	3.0	6.26			
			80/67	41.6	36.7	54.2	3.7	11.2	70	63.1		52.8	3.3	5.55			
			85/71	44.4	38.0	57.0	3.7	12.0	80	61.7		50.4	3.7	4.94			
110		6	0.9	75/63	34.6	33.4	49.5	4.5	7.7	Extended Range - Anti-freeze required		1.0	60	57.7	48.5	3.0	5.7
				80/67	36.9	34.7	52.0	4.5	8.2				70	56.7	46.6	3.3	5.09
				85/71	39.2	36.3	54.5	4.5	8.7				80	55.8	44.6	3.6	4.55
	9	1.9	75/63	35.7	34.0	50.0	4.3	8.4	60		61.9	52.7	3.0	6.04			
			80/67	38.3	35.3	52.6	4.3	9.0	70		60.7	50.5	3.3	5.38			
			85/71	40.8	36.8	55.2	4.2	9.6	80		59.6	48.2	3.6	4.79			
	12	3.1	75/63	36.4	34.2	50.3	4.1	8.8	60		64.5	55.0	3.0	6.26			
			80/67	39.0	35.7	52.9	4.1	9.4	70		63.1	52.8	3.3	5.55			
			85/71	41.7	37.0	55.6	4.1	10.1	80		61.7	50.4	3.7	4.94			

Extended Range - Anti-freeze required
 AHRI/ISO13256-1 certified performance is rated at entering air conditions of 80.6°F DB and 66.2°F WB in cooling and 68°F DB in heating.
 Tabulated unit performance does not include fan or pump power corrections required for AHRI/ISO standard performance ratings.
 Unit performance may be interpolated. Extrapolation is not allowed.
 For conditions other than rating conditions provided, consult the BST selection software.
 Ratings below 40°F are with a methanol solution.

DISCLAIMER: The performance reported herein is based on testing by FHP. Variations in the installation and operational environment may alter performance. Bosch disclaims all warranties, express and implied, that the performance will be as reported, including the warranty of merchantability and fitness for purpose. In addition, continuous research and development may result in a change to an appliances design and specifications at the time of order, which Bosch may change without notice. Before purchase, confirm the design specifications of the appliance.



Antifreeze Correction							
Antifreeze Type	Antifreeze %	Cooling			Heating		WPD Correction Factor EWT 30 °F
		EWT 90 Deg.F			EWT 30 Deg. F		
		Total Cap.	Sens. Cap	Power	Htg. Cap	Power	
Water	0	1.000	1.000	1.000	1.000	1.000	1.000
Propylene Glycol	5	0.997	0.997	1.004	0.989	0.997	1.06
	10	0.994	0.994	1.006	0.986	0.995	1.125
	15	0.990	0.990	1.009	0.978	0.988	1.19
	25	0.983	0.983	1.016	0.960	0.979	1.3
Methanol	5	0.997	0.997	1.003	0.990	0.997	1.06
	10	0.996	0.996	1.005	0.979	0.993	1.1
	15	0.994	0.994	1.008	0.970	0.990	1.14
Ethanol	5	0.998	0.998	1.002	0.981	0.994	1.16
	10	0.996	0.996	1.004	0.960	0.988	1.23
	15	0.992	0.992	1.006	0.944	0.983	1.280
	25	0.986	0.986	1.009	0.917	0.974	1.4
Ethylene Glycol	5	0.997	0.997	1.003	0.993	0.998	1.06
	10	0.995	0.995	1.004	0.986	0.996	1.12
	15	0.992	0.992	1.005	0.980	0.993	1.19
	25	0.988	0.988	1.009	0.970	0.990	1.33
	30	0.985	0.985	1.012	0.965	0.987	1.4



WARNING:
These electric heaters can only be installed in factory default blower configuration only.

Field Installed Accessory - Internally Mounted Electric Heat Kits

Part Number	Kilowatt Heater - 208/230V	Availability per Unit						
		BP012	BP018	BP024	BP030	BP036	BP042	BP048
8733952087	Electric Heat - 3.6/4.8 kW (5kW)	•	•	•	•	•	•	•
8733952088	Electric Heat - 7.8/9.6 kW (10kW)			•	•	•	•	•
8733952089	Electric Heat - 10.8/14.4 kW (15kW)				•	•	•	•
8733952090	Electric Heat - 14.4/19.2 kW (20kW)						•	•



It is recommended to use a seven (7) conductor cable for thermostat interface.

Field Installed Accessory - Pump/Valve Relay Kit

Part Number	BP012		BP018		BP024		BP030		BP036		BP042		BP048	
	VT	HZ	VT	HZ	VT	HZ	VT	HZ	VT	HZ	VT	HZ	VT	HZ
8733951906	•	•	•	•	•	•	•	•	•	•	•	•	•	•

Field Installed Accessory - Swivel Connector Kit (two connectors per package)

Order Number	Type & Size	BP012		BP018		BP024		BP030		BP036		BP042		BP048	
		VT	HZ	VT	HZ	VT	HZ	VT	HZ	VT	HZ	VT	HZ	VT	HZ
7738003200	Male 3/4" NPT	•	•	•	•	•	•								
7738003201	Male 1" NPT							•	•	•	•	•	•	•	•



Swivel connectors have a maximum pressure rating of 125 PSI.

Field Installed Accessory - SmartStart Assist Kit														
Part Number	BP012		BP018		BP024		BP030		BP036		BP042		BP048	
	VT	HZ	VT	HZ	VT	HZ	VT	HZ	VT	HZ	VT	HZ	VT	HZ
8733957159	•	•	•	•	•	•	•	•	•	•	•	•		
8733957160													•	•

Field Installed Accessory - Duct Mounted Electric Heaters 208/230V							
Nominal BTUH	Order #				Nominal CFM	Duct Flange Connection in Inches	Nominal Dimension in Inches
	5 kW	10 kW	15 kW	20 kW			
18000	7738002745	N/A	N/A	N/A	600	13.75 x 13.75	14 x 14
24000	7738002746	7738002747	N/A	N/A	800	13.75 x 13.75	14 x 14
30000	7738002748	7738002749	N/A	N/A	1000	15.75 x 15.75	16 x 16
36000	7738002748	7738002749	N/A	N/A	1200	15.75 x 15.75	16 x 16
42000	7738002747	7738002751	7738002752	N/A	1400	17.75 x 17.75	18 x 18
48000	7738002747	7738002751	7738002752	N/A	1600	17.75 x 17.75	18 x 18
60000	7738002747	7738002751	7738002752	7738002753	2000	17.75 x 17.75	18 x 18
70000	7738002747	7738002751	7738002752	7738002753	2200	17.75 x 17.75	18 x 18

i Duct mounted heaters are only available in single phase 208/230 V. Please refer to Manufacturer's Installation and Operation Manual for proper installation and guidelines. It is recommended to use a seven (7) conductor cables for thermostat interface. It is required for the duct mounted heater to have an independent power supply. In fiberglass duct systems, a metal sleeve **MUST** be used as an insert and support to the heater.

GreenSource i Series Model BP
Residential Geothermal Heat Pumps



Field Installed Accessory - Stainless Steel Hose Kits						
Options	Option 1	Option 2	Option 3**	Option 4**,***	Option 5**, ***	Option 6**, ***
Hose Size (Length, Diameter)	Hoses Only with Swivel	Hose Kit Hoses with Ported Ball Valves, Swivel and One P/T*	Hose Kit with Automatic Flow Valve (AFV)*	Hose kit with AFV, Y-Strainer & Blow Down Valve*	Hose Kit with AFV and Electric Valve*	Hose Kit with AFV, Y-Strainer, BDV and Electric Valve*
	Part #	Part #	Part #	Part #	Part #	Part #
12 Inch						
1/2" L	T111H02121	T111H02122	T111H02123	T111H02124	T111H02125	T111H02126
24 Inch						
3/4" S	T111H03241	T111H03242	T111H03243	T111H03244	T111H03245	T111H03246
1" L	T111H04241	T111H04242	T111H04243	T111H04244	T111H04245	T111H04246
1" S	T111H04241	T111H04242	T111H04247	T111H04248	T111H04249	T111H04240
1 - 1/4" S	T111H05241	T111H05242	T111H05243	T111H05244	T111H05245	T111H05246
1 - 1/2" L	T111H06241	T111H06242	T111H06243	T111H06244	T111H06245	T111H06246
1 - 1/2" S	T111H06241	T111H06242	T111H06247	T111H06248	T111H06249	T111H06240
2" S	T111H08241	T111H08242	T111H08243	T111H08244	T111H08245	T111H08246
36 Inch						
3/4" S	T111H03361	T111H03362	T111H03363	T111H03364	T111H03365	T111H03366
1" L	T111H04361	T111H04362	T111H04363	T111H04364	T111H04365	T111H04366
1" S	T111H04361	T111H04362	T111H04367	T111H04368	T111H04369	T111H04360
1 - 1/4" S	T111H05361	T111H05362	T111H05363	T111H05364	T111H05365	T111H05366
1 - 1/2" L	T111H06361	T111H06362	T111H06363	T111H06364	T111H06365	T111H06366
1 - 1/2" S	T111H06361	T111H06362	T111H06367	T111H06368	T111H06369	T111H06360
2" S	T111H08361	T111H08362	T111H08363	T111H08364	T111H08365	T111H08366

* All Hose Kits include S/R ported ball valves with swivel and P/T port.

** 'L' and 'S' only apply to kit options 3 through 6

*** GMP's are required for hose kits in options 3-6

Hose Kit Flow Rates by Size
<p>Please see Technical Service Bulletin: Heat Pump Hose Kits – Water Flow Rates. This document is located at https://www.bosch-homecomfort.com/us/media/country_pool/documents/service-bulletins/hp_hose_kits_water_flow_rates_bulletin_us.pdf.</p>

GreenSource i Series Model BP Residential Geothermal Heat Pumps



Field Installed Accessory - Bosch Connected Control Wi-Fi Thermostat

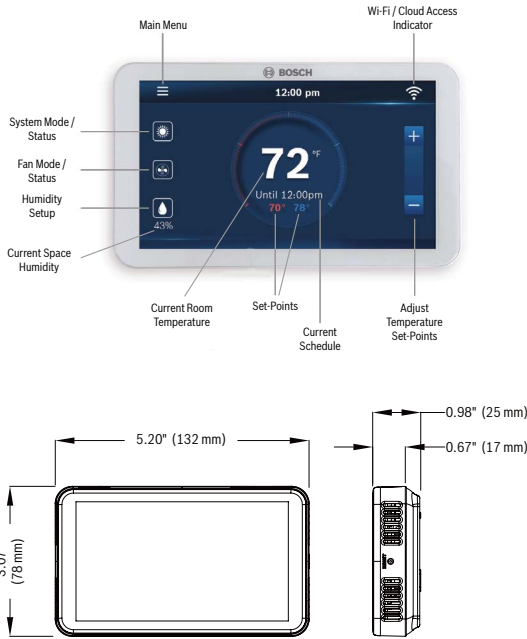

Description	Part Number	Heat	Cool	Humidity
Bosch Connected Control (BCC100)	8-733-948-009	4	2	Yes

Specifications

- 5 Inch Touch Screen 854 x 480 Pixels
- 7 Relay Outputs (Terminals) G, Y1, Y2, W1, W2, O/B, H/dH
- 1 Data Input (Alarm pulse signals from Bosch WSHP)
- Displays Bosch Water Source Heat Pump Fault Messages
- Wi-Fi (802.11a/b/g/n) 2.4GHz (not compatible with 5GHz)
- FCC and IC Certification
- 5 Year Limited Warranty (see website for details: <https://www.bosch-homecomfort.com/us/en/residential/service/product-warranty-library/thermostats-controls-warranty-documents/>)

Compatibility

- Conventional (Gas, Oil, Electric): Up to 2 Heat / 2 Cool
- Heat Pump (O/B to energize reversing valve in cool/heat): Up to 4 Heat / 2 Cool
- Supports up to 1 Accessory Unit: Humidifier or Dehumidifier (not provided by Bosch)
- Unit Modes: Heat, Cool, Auto, Off, Emergency Heat (Heat Pump & Dual Fuel only)
- Fan Modes: Auto, On, Circulate
- Supports 2 Transformer Systems (Rh and Rc)
- C-Wire Required for Installation
- Supports Active and Passive Dehumidification without the need for external relays, such as Bosch Water Source Heat Pump products equipped with a Hot Gas Reheat Coil and/or ECM motor

GreenSource i Series Model BP Residential Geothermal Heat Pumps



Field Installed Accessory - Bosch Connected Control Wi-Fi Thermostat

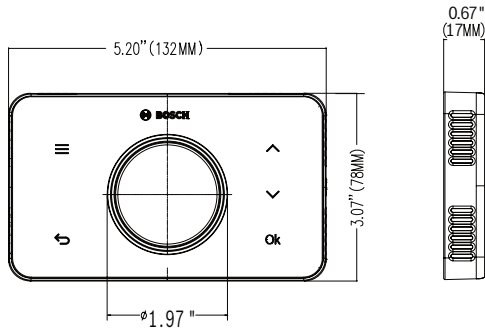
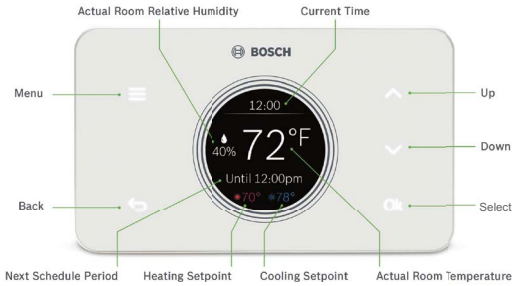

Description

Bosch Connected Control (BCC50)

Part Number

8-733-952-994

Heat

3

Cool

2

Humidity

Yes

Specifications

- 2.8 Inch Non-Touch LCD Screen 240 x 320 Pixels
- 5 Back-lit Touch Buttons
- 6 Relay Terminals: G, Y1, Y2, W/E/AUX, O/B/W2, H/DH
- Wi-Fi (802.11b/g/n) 2.4GHz (not compatible with 5GHz)
- FCC and IC Certification
- 3 Year Limited Warranty (see <https://www.bosch-homecomfort.com/us/en/residential/service/product-warranty-library/thermostats-controls-warranty-documents/> for details)

Compatibility

- Conventional (Gas, Oil, Electric): Up to 2 Heat / 2 Cool
- Heat Pump (O/B/W2 to energize reversing valve in cool/heat): Up to 3 Heat / 2 Cool
- Supports up to 1 Accessory Unit: Humidifier or Dehumidifier (not provided by Bosch)
- Unit Modes: Heat, Cool, Auto, Em Heat (Heat Pump & Dual Fuel only), Off
- Fan Modes: Auto, On, Circulate
- Supports 2 Transformer Systems (Rh and Rc)
- C-Wire Required for Installation
- Supports Active and Passive Dehumidification without the need for external relays, such as Bosch Water Source Heat Pump products equipped with a Hot Gas Reheat Coil and/or ECM motor