

SM RevC Field Installed Internal Electric Heat Kit

HK050 | HK100 | HK150 | HK200



BOSCH

Installation Manual

Table of Contents

1 Key to Symbols and Safety Instructions	4
1.1 Key to Symbols	4
1.2 Safety Warnings	4
2 Introduction	5
3 Pre-Installation	5
3.1 Unpacking and Inspection	5
3.2 Component List	5
4 Electric Heat Kit Configuration	6
5 Installation - Hardware	7
5.1 Removing Panels - VT Units	7
5.2 Removing Panels - HZ Units	9
5.3 Electric Heat Element Installation	10
5.4 Electric Heat Element Control Box Installation	12
5.5 Electric Heat Element Wiring	13
5.6 Discharge Air Probe Installation	16
5.7 Field Line Voltage Connection	17
5.8 Thermostat Wire Connections	18
5.9 Wiring Diagram Replacement/Data Plate Placement	18
5.10 Unit Panel Reinstallation	18
6 Unit Start Up	19
7 Information on Decommissioning	19
8 Electrical Data and Diagrams	20

1 Key to Symbols and Safety Instructions

1.1 Key to Symbols

Warnings



Warnings in this document are identified by a warning triangle printed against a grey background.

Keywords at the start of a warning indicate the type and seriousness of the ensuing risk if measures to prevent the risk are not taken.

The following keywords are defined and can be used in this document:

- ▶ **DANGER** indicates a hazardous situation which, if not avoided, will result in death or serious injury.
- ▶ **WARNING** indicates a hazardous situation which, if not avoided, could result in death or serious injury.
- ▶ **CAUTION** indicates a hazardous situation which, if not avoided, could result in minor to moderate injury.
- ▶ **NOTICE** is used to address practices not related to personal injury.

Important information



This symbol indicates important information where there is no risk to people or property.

1.2 Safety Warnings



WARNING:

- ▶ Installation and servicing of this equipment can be hazardous due to system pressure and electrical components. Only trained and qualified personnel should install, repair, or service the equipment.



WARNING:

- ▶ Before performing service or maintenance operations on the system, turn off main power to the unit. Electrical shock could cause personal injury or death.



HK Series Heater Package can only be installed on single phase units.



A heater collar is installed in the unit, there is no need to order it separately.



WARNING:

- ▶ When working on equipment, always observe precautions described in the literature, tags, and labels attached to the unit. Follow all safety codes. Wear safety glasses and work gloves. Use a quenching cloth for brazing, and place a fire extinguisher close to the work area.

NOTICE:

- ▶ To avoid the release of refrigerant into the atmosphere, the refrigerant circuit of this unit must be serviced only by technicians who meet local, state, and federal proficiency requirements.

NOTICE:

- ▶ All refrigerant discharged from this unit must be recovered WITHOUT EXCEPTION. Technicians must follow industry accepted guidelines and all local, state, and federal statutes for the recovery and disposal of refrigerants. If a compressor is removed from this unit, refrigerant circuit oil will remain in the compressor. To avoid leakage of compressor oil, refrigerant lines of the compressor must be sealed after it is removed.

NOTICE:

- ▶ To avoid equipment damage, DO NOT use these units as a source of heating or cooling during the construction process. Doing so may affect the unit's warranty. The mechanical components and filters will quickly become clogged with construction dirt and debris, which may cause system damage.



WARNING:

- ▶ This product can expose you to chemicals including Lead and Lead components, which are known to the State of California to cause cancer and birth defects or other reproductive harm. For more information go to www.P65Warnings.ca.gov.



A heat pump thermostat with supplemental electric heat feature is required to operate the system when this kit is installed.

2 Introduction

Bosch HK Series Heater Package is a field installed electric resistance heater kit designed for the SM RevC series heat pumps.

The HK series heater package requires a separate electrical service connection, independent from the heat pump's power supply. Hence, installation of this Heater Package will convert the heat pump into a two point power connection.

The HK series Heater Package is available in several kW capacities, unit tonnage vs. Heater Package capacity compatibility table is shown below. The HK series Heater Package can be installed on Vertical (VT), Horizontal [end blow only] (HZ) units.

Unit Model	Heater Compatibility			
	HK050-1201	HK100-1201	HK150-1201	HK200-1201
SM024*	X	X		
SM036*	X	X	X	
SM048*	X	X	X	X
SM060*	X	X	X	X
SM070*	X	X	X	X

Table 1 Unit / Heater Compatibility

* HK Series Heater Packages are designed for SM RevC models only.

3 Pre-Installation

3.1 Unpacking and Inspection

1. Unpack the heater kit and inspect for contents and condition. If any part of the kit appears damaged (i.e.: broken heater elements, damaged relays) or missing, do not attempt to install the kit. Contact your local distributor for further help.
2. Ensure that the heater kit package includes all of the items listed in figure 1.
3. For the installation you will need several tools which are not included with the kit. Refer to the Required Tools List below and be sure to have these items with you for the install.

i For technical assistance contact your local distributor or Bosch Technical Support: 1-866-642-3198 or Bosch.FhpTechSupport@us.bosch.com.

3.2 Component List

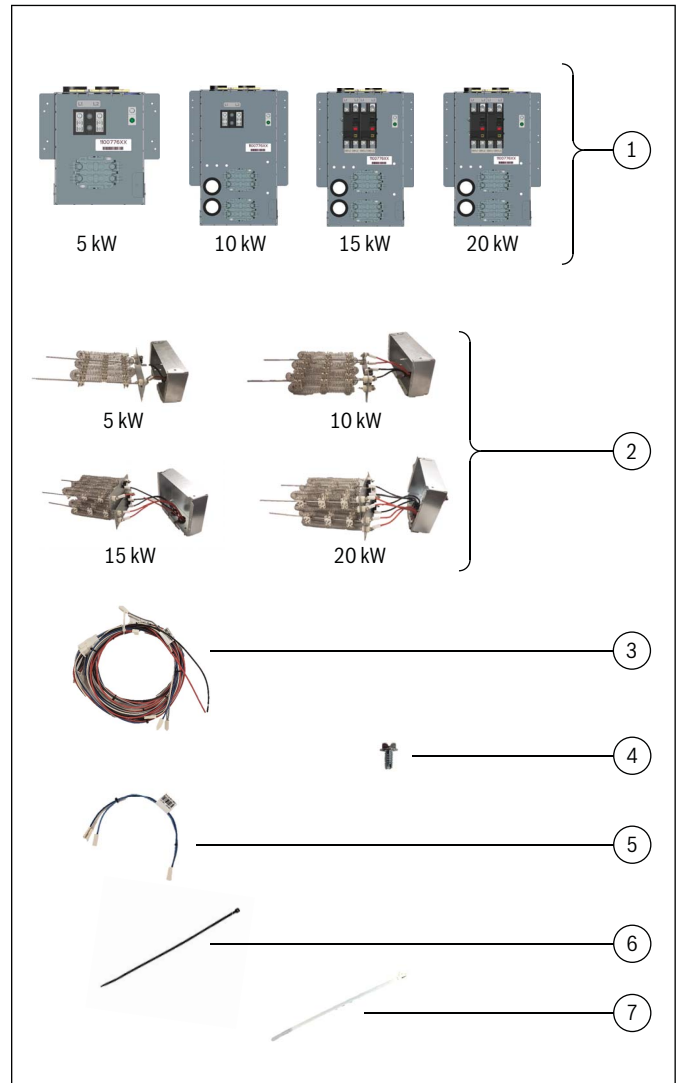

Figure 1 Kit Components

Components:

- [1] Electric Control Box per kW Capacity (qty - 1)
- [2] Electric Heat Elements per kW Capacity (qty - 1)
- [3] Electric Heat Harness (qty - 1)
- [4] Hex Head Machine Screw (qty -12)
- [5] J39 Plug Harness (qty - 1)
- [6] Black Zip Tie (qty - 3)
- [7] White Hole Fastener Zip Tie (qty - 2)



Labels come pre-installed on the electric control box.

Required tools list

- ▶ Phillips screwdriver
- ▶ Small flat head screwdriver
- ▶ 5/16" socket and a ratchet or drill
- ▶ 12" Ratchet/Socket Extender

4 Electric Heat Kit Configuration

Figures 2 and 3 show where the Electric Heat Element (position 1) and the Electric Control Box (position 2) will be installed in VT and HZ Left and Right units.

i Pictures do not represent a specific unit, and are meant for reference purposes only. However location of the electric heat kit remains the same for SM, CE, and BP Models.

VT Units

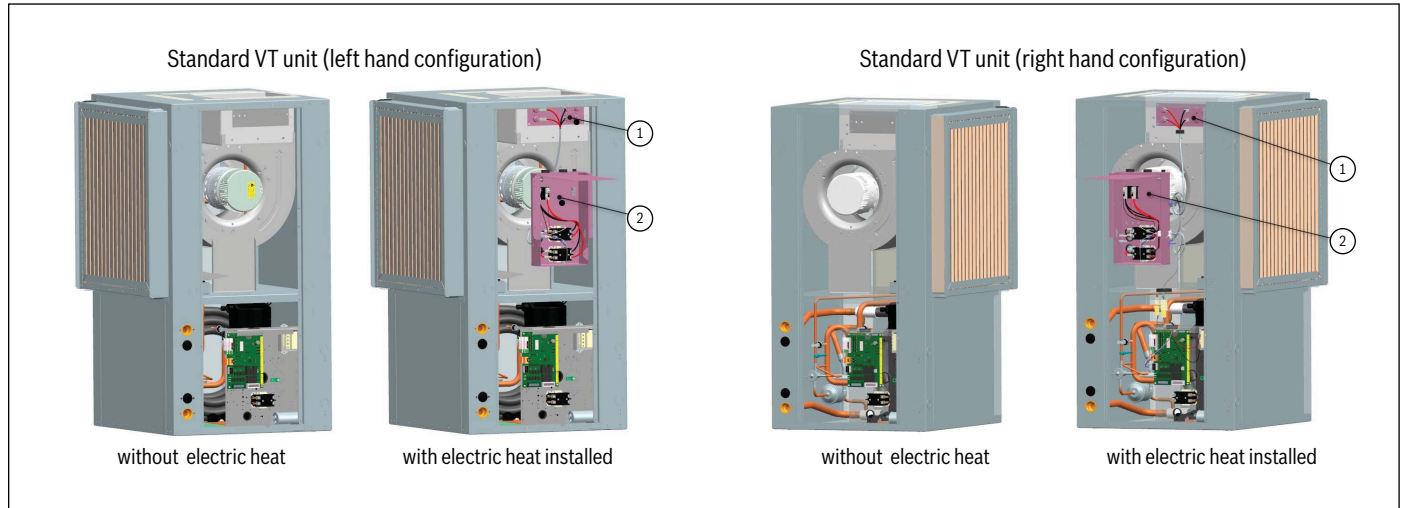

Figure 2 VT units before/after electric heat installation

HZ Units

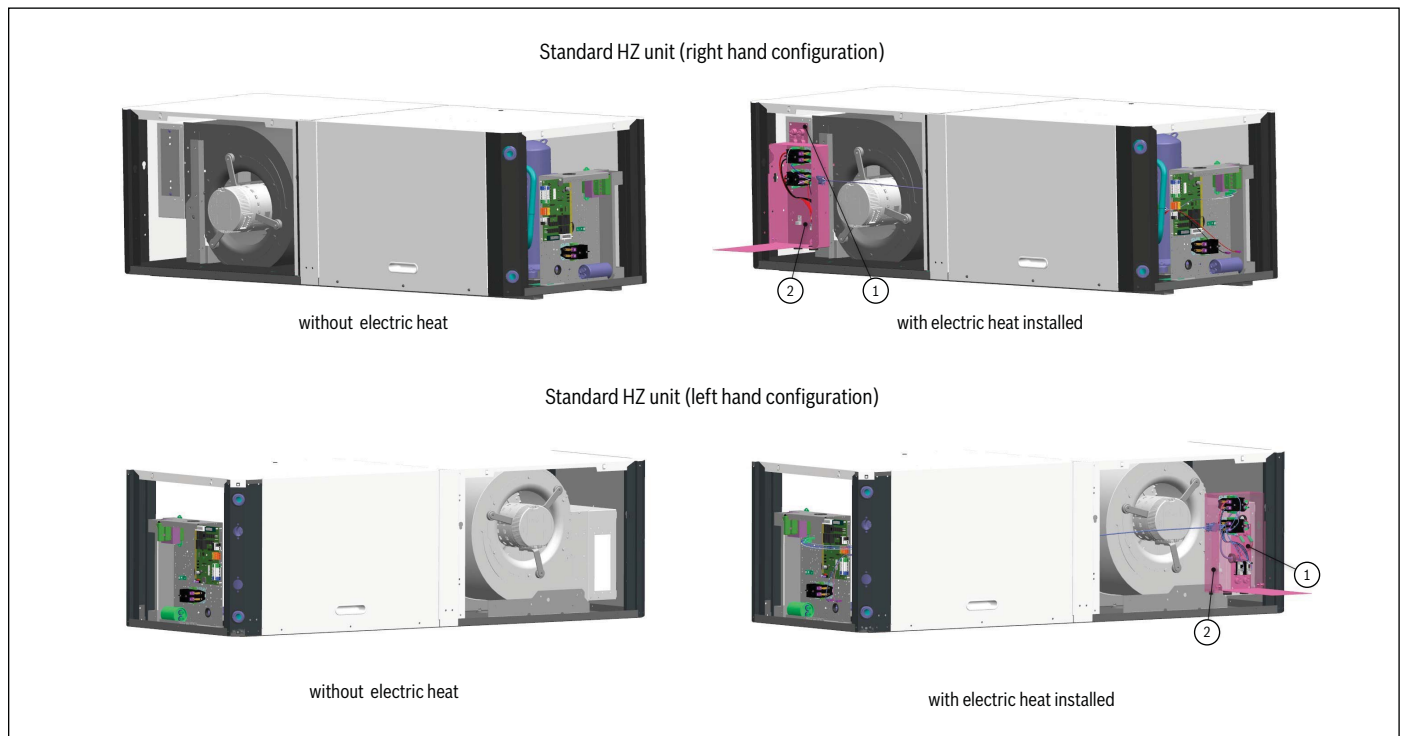

Figure 3 HZ units before/after electric heat installation

5 Installation - Hardware

5.1 Removing Panels - VT Units

1. At thermostat, turn system to "OFF".
2. Turn the main power to the heat pump to "OFF" at the unit's disconnect switch or breaker panel.



WARNING:

- ▶ Follow appropriate lockout/tag out procedure.

3. Remove the access panels, exposing the blower section and compressor section.
4. Remove the bottom panel first by unscrewing the 2 fasteners from the bottom panel (figure 4).

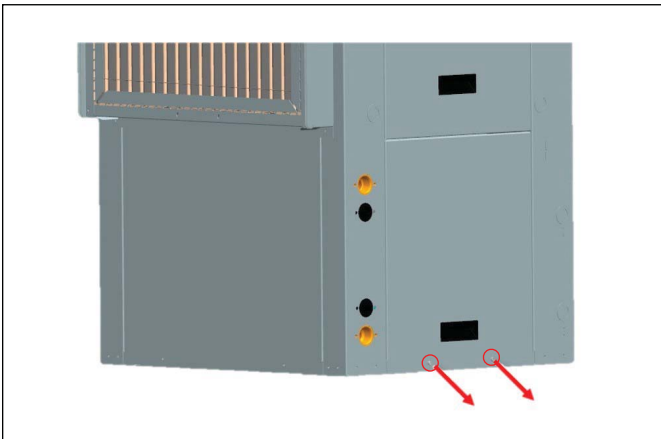

Figure 4

5. Rotate bottom panel 45 degrees (figure 5).

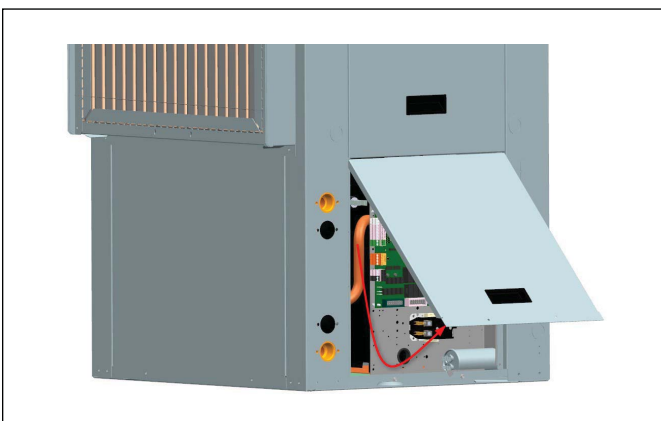

Figure 5

6. Slide out bottom panel (figures 6 and 7).

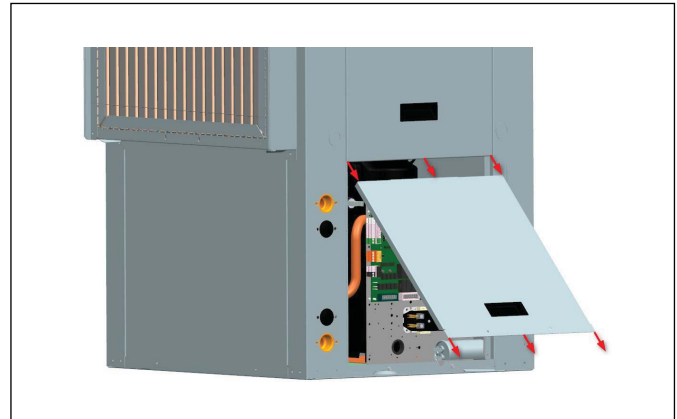

Figure 6

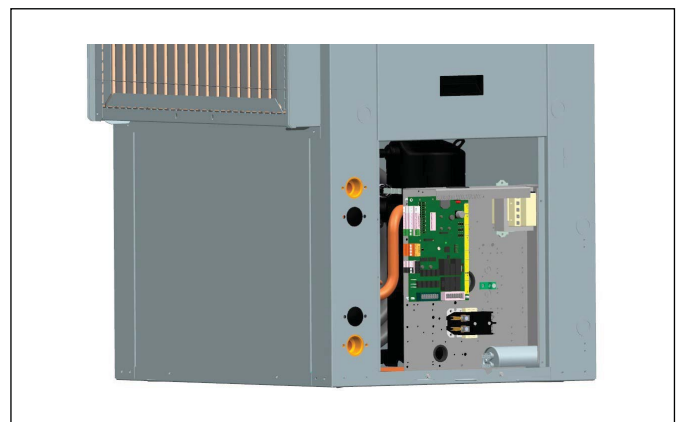

Figure 7

7. After the bottom panel has been removed, remove the top panel by unscrewing the 2 fasteners from the top panel (figure 8).

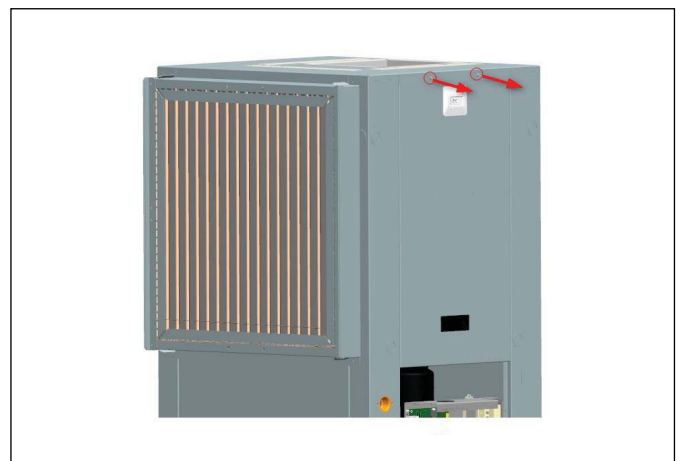

Figure 8

8. Slide the top panel down slightly. Be cautious as there is a unit display plugged into the panel (figures 9 and 10).



Figure 9

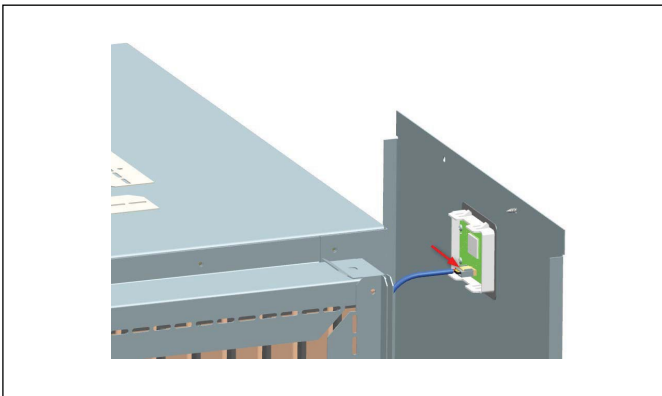

Figure 10

9. Unplug the unit display plug (figure 11).

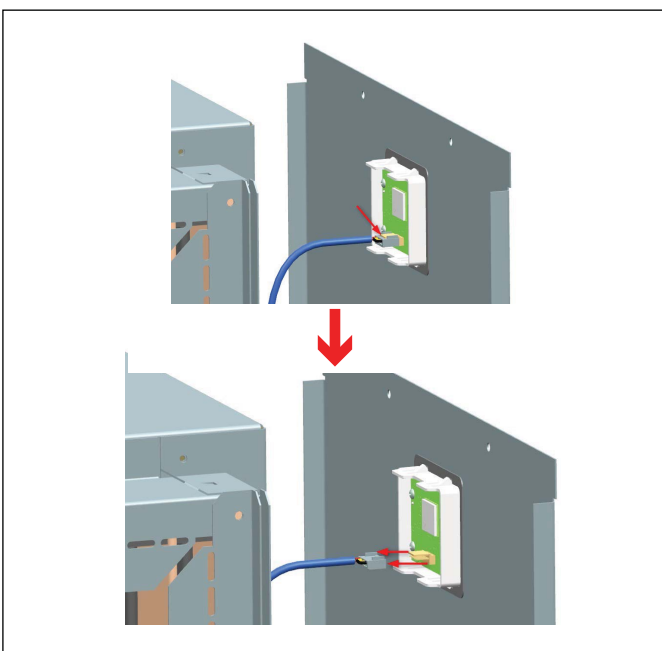

Figure 11

10. Remove the top panel (figure 12).

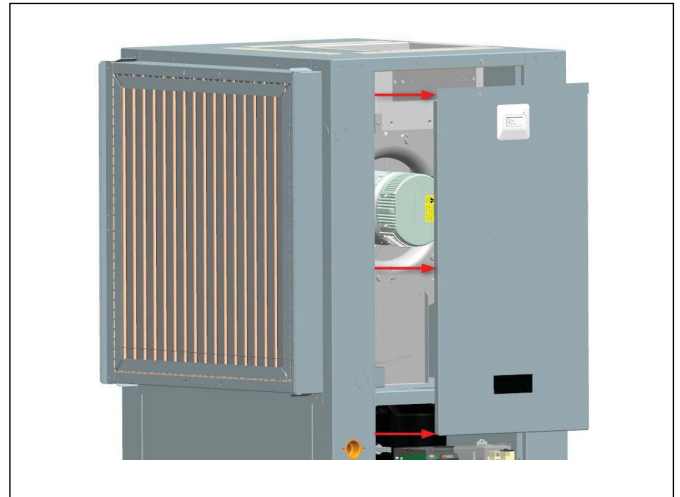

Figure 12

11. The blower section and compressor section should be exposed. (figure 13 VT Left unit with top and bottom panels removed).



Figure 13

5.2 Removing Panels - HZ Units

1. At thermostat, turn system to "OFF".
2. Turn the main power to the heat pump to "OFF" at the unit's disconnect switch or breaker panel.



WARNING:

▶ Follow appropriate lockout/tag out procedure.

3. To install, remove the access panels (figure 14), exposing the blower section (side, pos.1), and the electrical panel (front, pos.2).

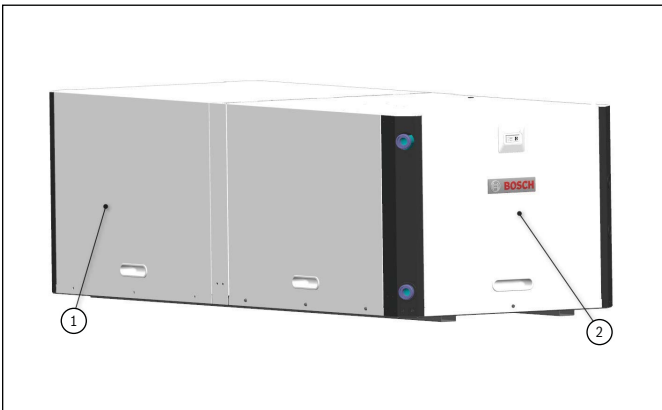

Figure 14

4. Remove the front panel first by unscrewing the screw at the bottom in the center of the panel (figure 15).



Figure 15

5. Slide front panel up and remove (figure 16).

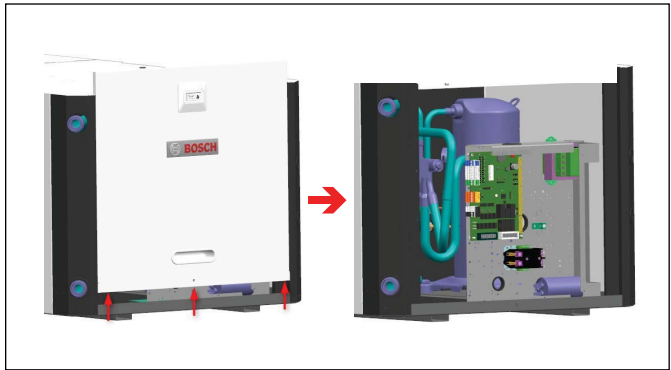

Figure 16

6. After the electrical panel has been removed, remove the blower panel by unscrewing the 3 screws at the bottom of the furthest panel on the left (figure 17).

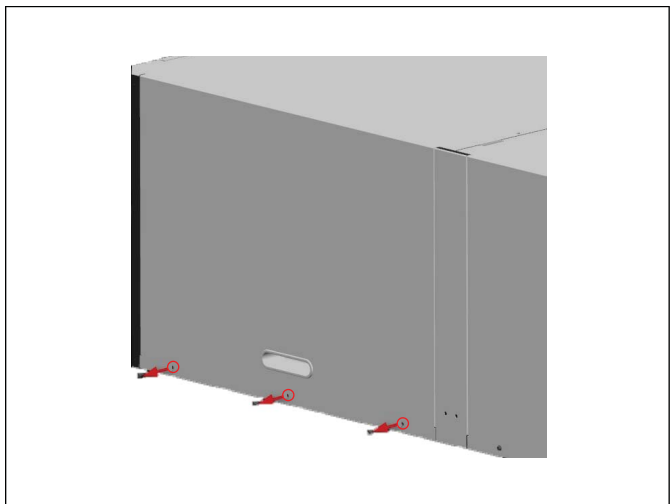

Figure 17

7. Once these three screws have been removed, slide the panel up and remove (figure 18).

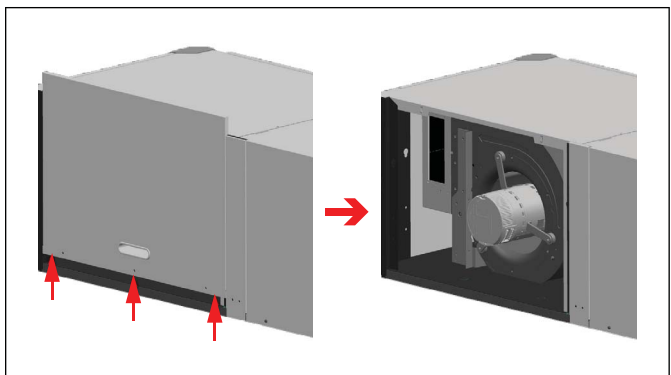

Figure 18

5.3 Electric Heat Element Installation

1. On the Electric Heat Element, cut the zip ties holding the element cover.
2. On the unit, unscrew and remove both heater collar cover plates (figures 19 & 20).

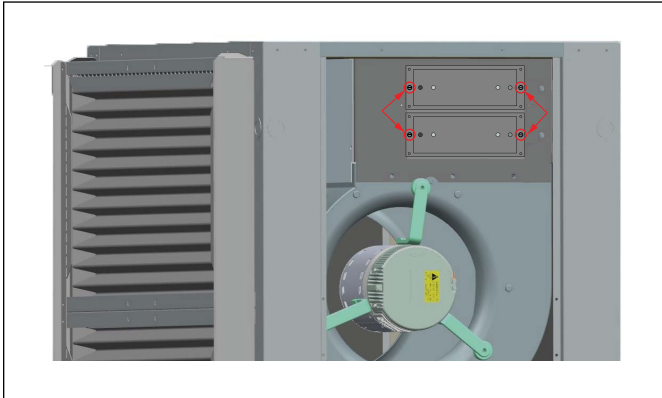

Figure 19

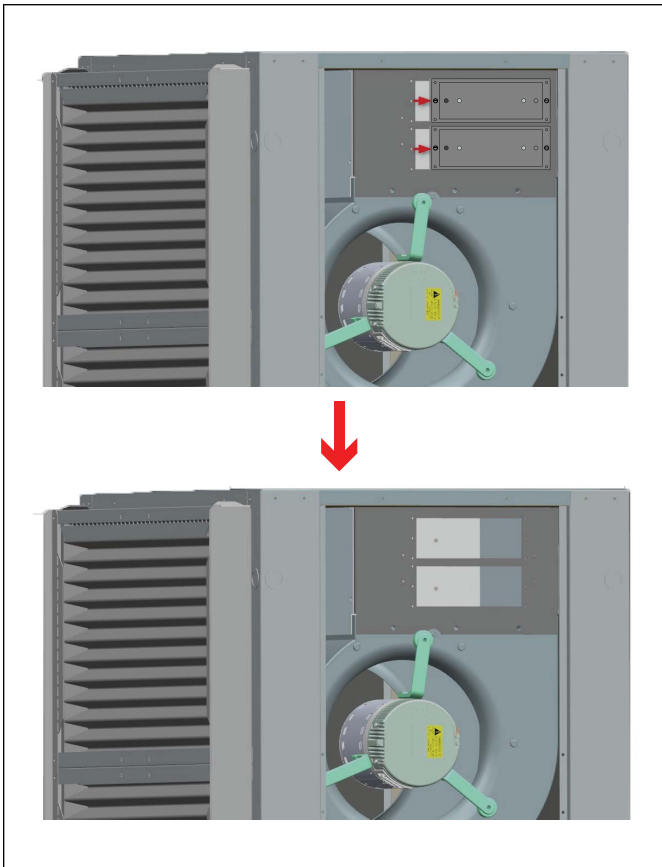

Figure 20

3. For the 036,048,060, and 070 models, an extension bracket will already be installed in the unit as shown in figure 21.

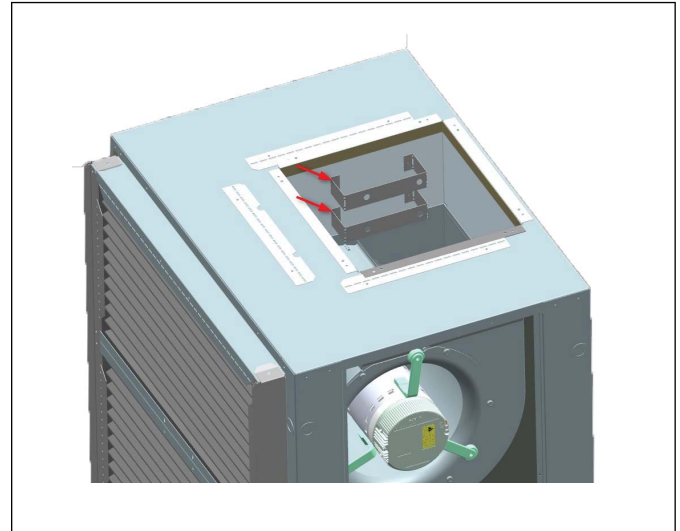

Figure 21 036, 048, 060, and 070 Models with Extension Bracket

4. Align the heating element to be inserted, make sure the coils are facing upwards and heater overloads are directly in-line with discharge air stream. (figure 22).

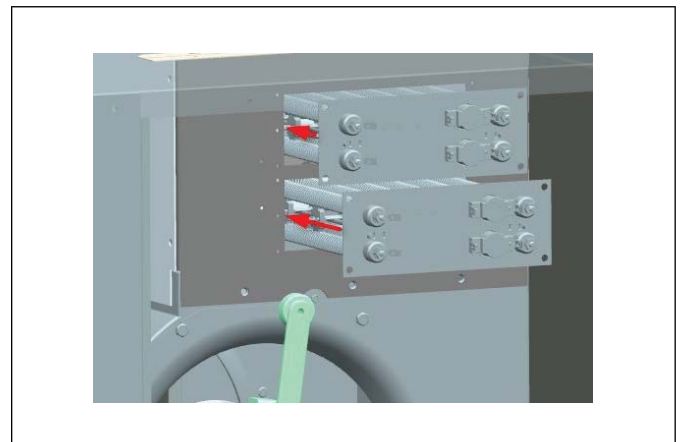

Figure 22 Electric Element Orientation

5. Start with the bottom insert for 5kW and 10kW kits, and both for the 15 kW and 20 kW. Slide in the heating element rods into the holes on either the extension bracket or heater collar (figure 23).

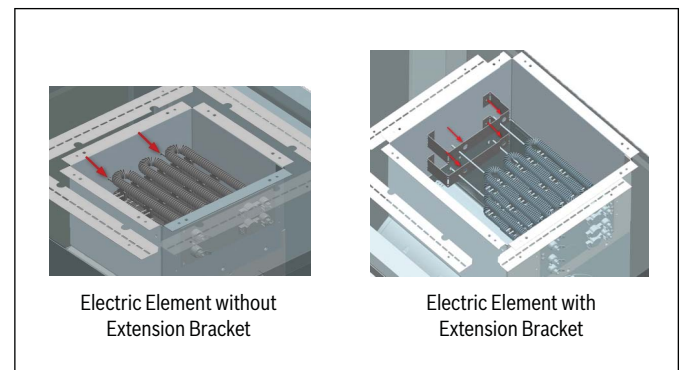

Figure 23 Electric Element Installed with/without Extension Bracket

- Screw the heating elements into place after they have been successfully inserted (figure 24).

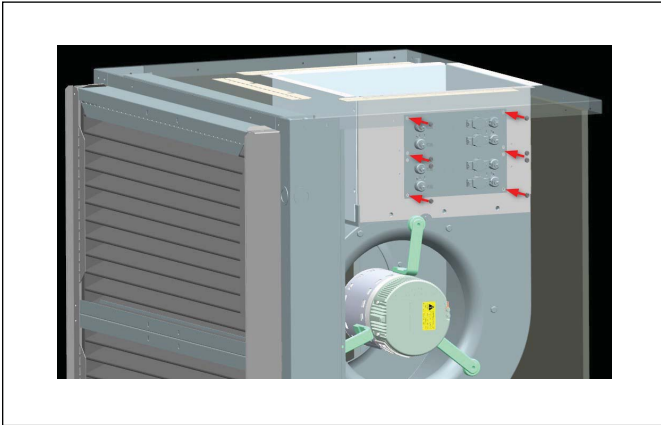

Figure 24

- For the 5kW and 10kW kits, reattach one of the heater collar cover plates on the insert above to keep it closed.
- The installed heating elements should look like the following for each kit (figure 25):

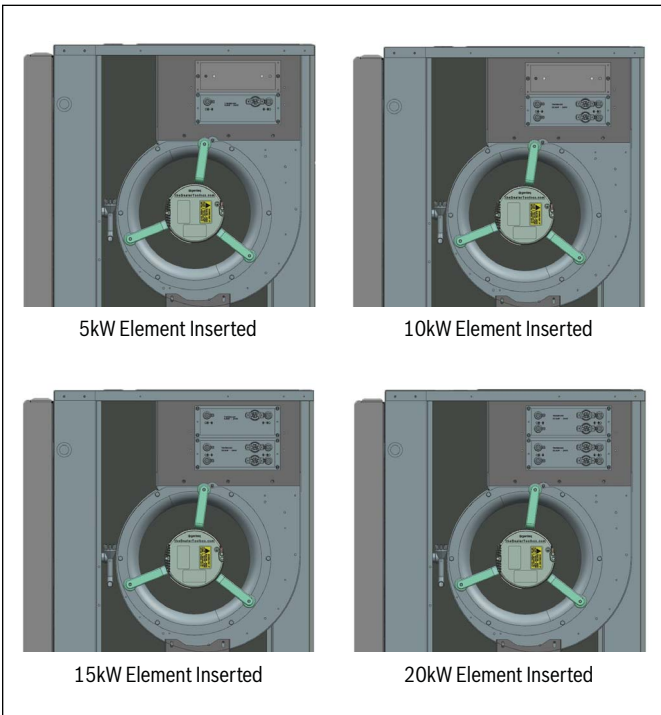

Figure 25

- After the heating elements are installed, move the element cover into position (figure 26).

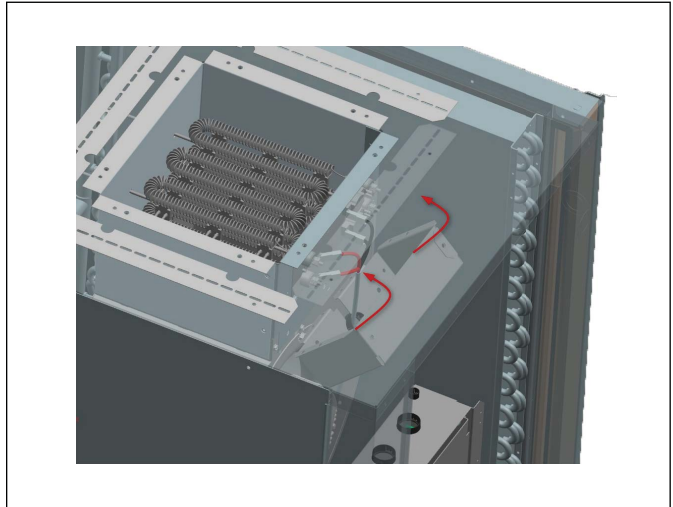

Figure 26

- Line the element cover with the holes on the heating collar and screw in (figure 27).

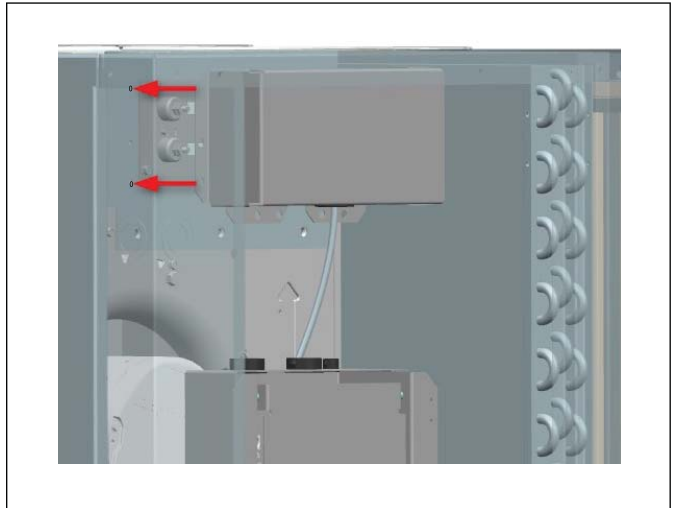

Figure 27

5.4 Electric Heat Element Control Box Installation

1. Determine if the configuration is left or right.
2. Align the EH control Box up with the mounting holes located on corner post opposite from Air Coil. Figure 28 shows mounting for right hand configuration.

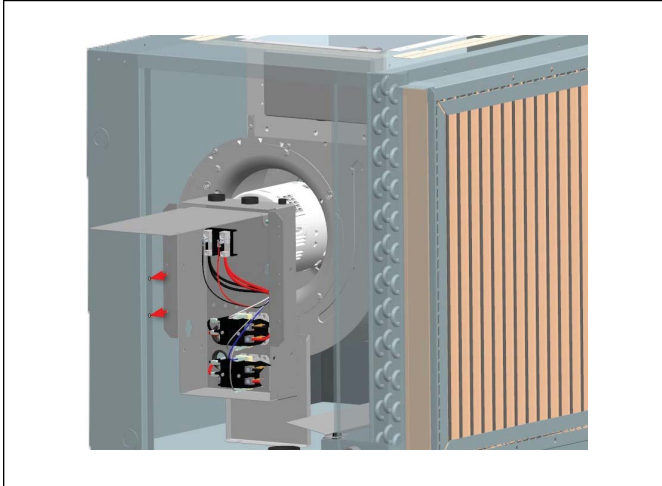

Figure 28

3. Secure with screws as shown to complete EH control box installation (figure 29).

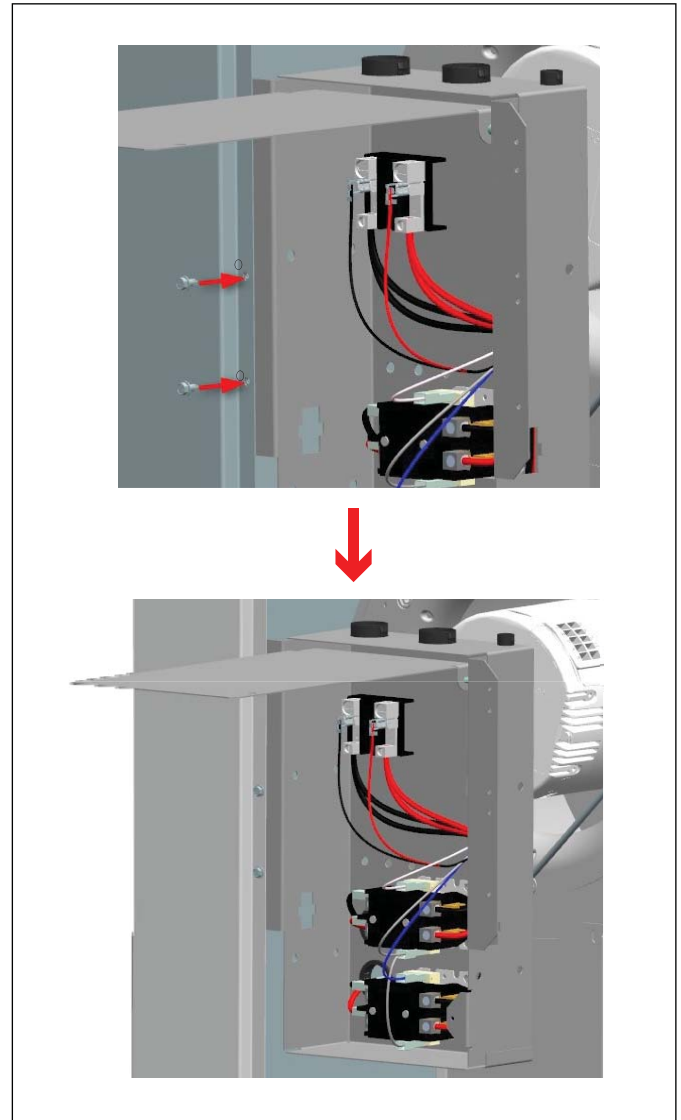

Figure 29

5.5 Electric Heat Element Wiring

1. On the EH Control Box, locate the loose J39 connector (figure 30).

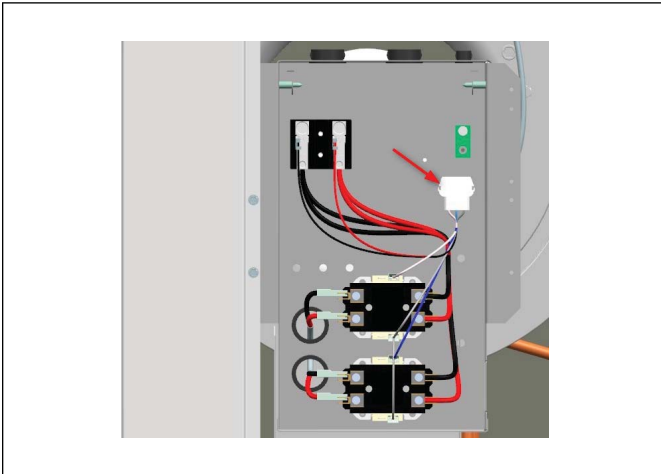

Figure 30

2. Locate the J39 mounting slot on the inner side of the EH Control box. Figure 31 shows connection slot for right hand configuration.

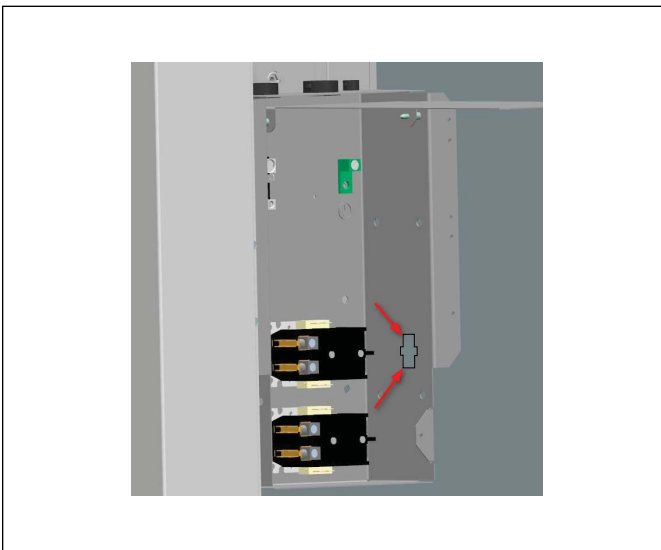

Figure 31

3. Line up the J39 connector, and insert into mounting slot. Figure 32 shows connection for right hand configuration. Figure 33 shows connection for left hand configuration.

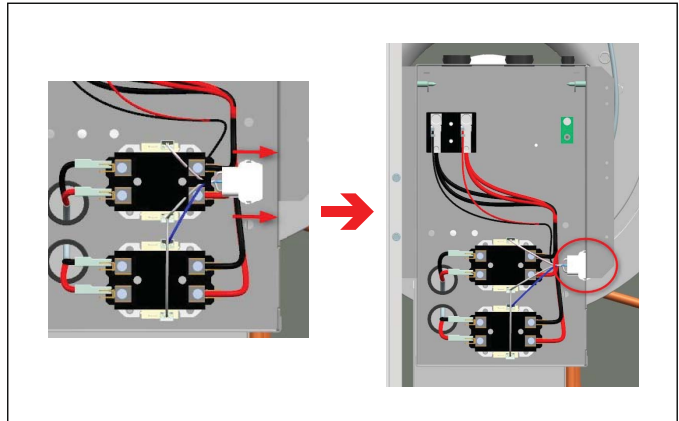

Figure 32 J39 Connector Right Hand Configuration

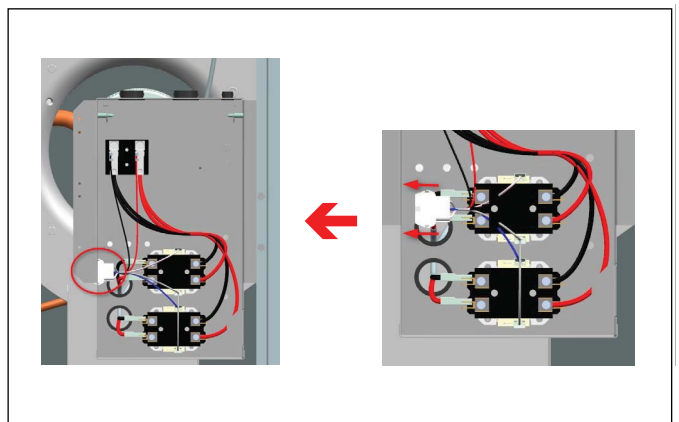

Figure 33 J39 Connector Left Hand Configuration

4. At the Unit Control Box, locate and unplug the transformer harness at both ends (figure 34). Discard this wire.

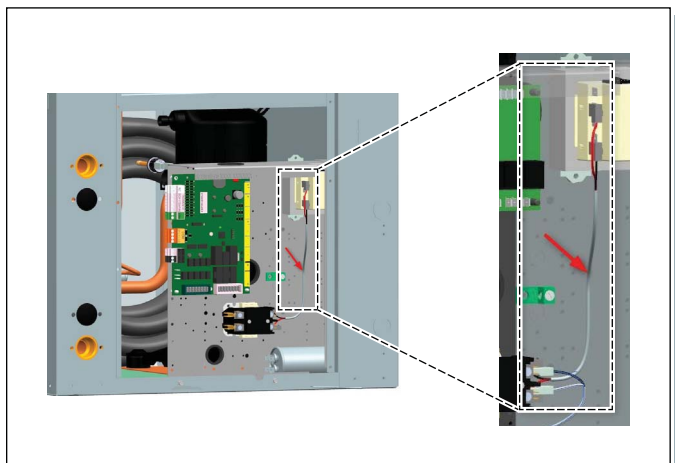

Figure 34

5. Locate the Blower Interconnect Harness, and unplug from the connector side and the compressor contactor side. (figure 35). Discard this wire.

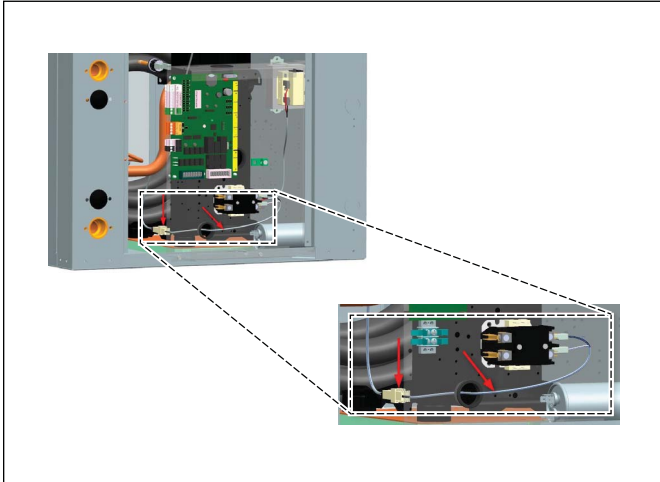

Figure 35

6. Now you will have a single connector as shown in figure 36.

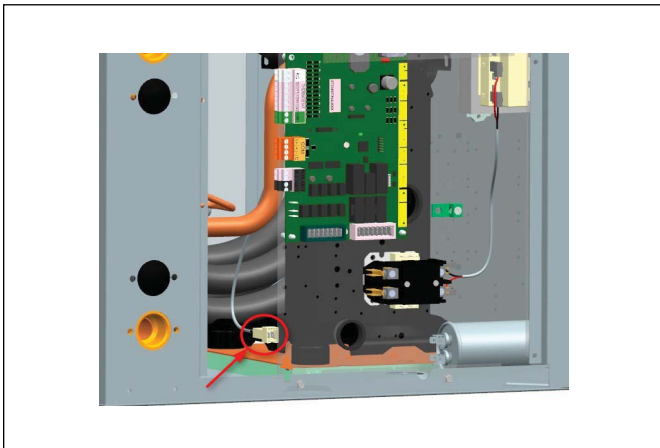

Figure 36

7. Taking this single connector from step 6, connect it to the J19 connector on the Electric Heat wiring harness (red and black wires). Feed just the T1 VOLT and T1 COM wires (two wires) through the top hole into the unit control box. Plug the T1 VOLT (red) into the transformer 240 V or 208V. Plug T1 COM (black) wire into the transformer COM. Typical connections are shown in figure 37.

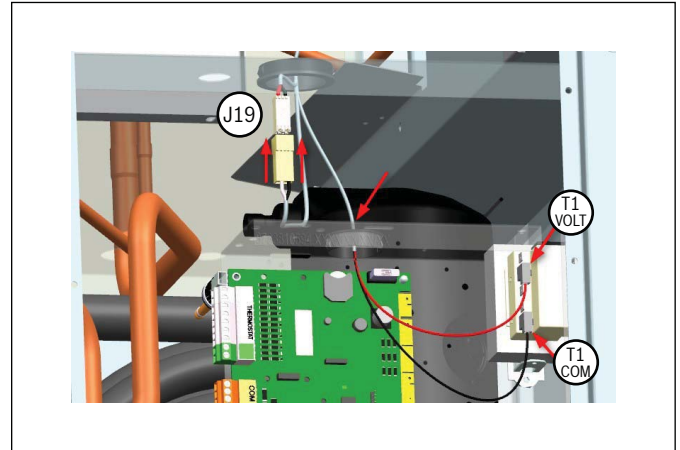

Figure 37

8. Continuing with the EH wiring harness, take the loose white, blue and grey wires (W1 and W2 and C), and feed them through the same hole into the unit control box. Connect wire labeled W1 to SR, W2/EM TO AUX and C to C respective terminals on the HPC as shown in figure 38 below.

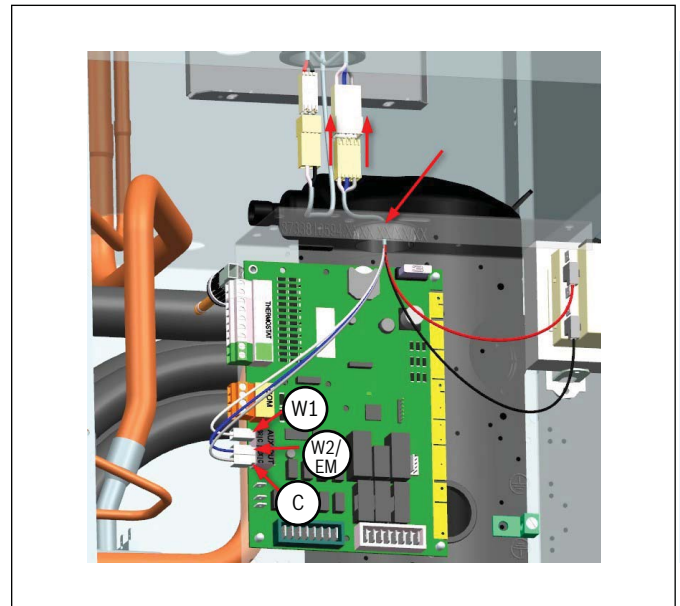

Figure 38

i Depending on the size of the unit, there may be excess wire slack from the length of the wiring harness. Use the provided zip-ties in the kit to neatly wrap up this excess wiring per preference.

9. The Unit Control Box wiring should look as shown in figure 39.

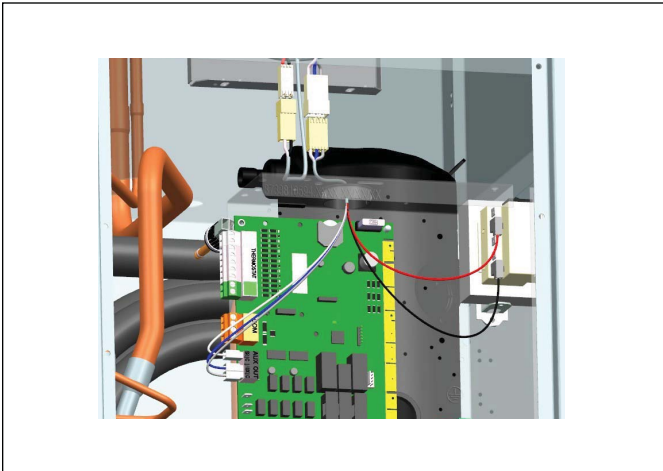

Figure 39

10. Take the male end of the J39 plug harness and fish it through the unit divider hole. Connect this plug into the female J39 connector (Figure 40, Pos. 1) on the side of the Electric Control Box. Using push tie straps provided, bundle excess element and control wiring (Figure 40, Pos. 2) as shown.

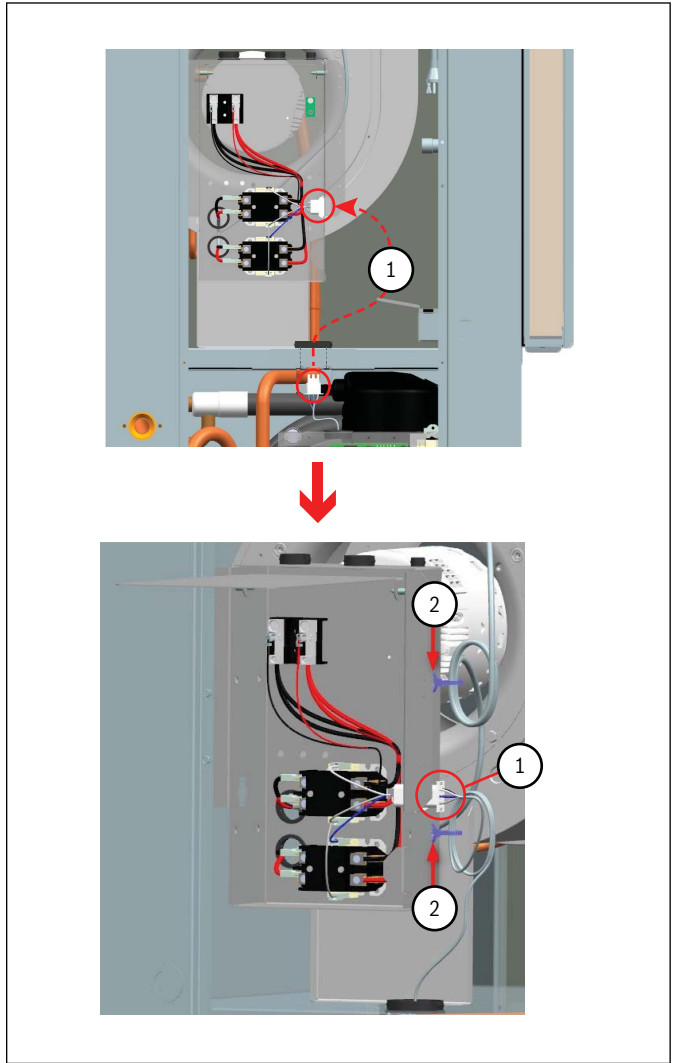

Figure 40

5.6 Discharge Air Probe Installation

1. Locate the closest available electrical knockout of the unit and the Discharge Air Interconnect in the Air Handler section as shown in Figure 41.

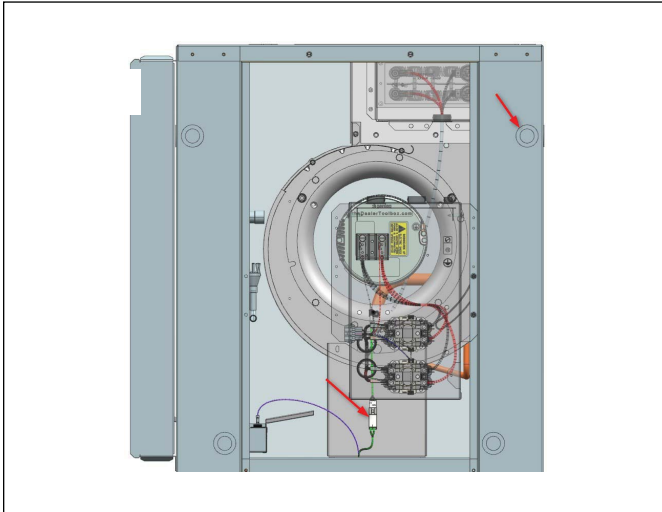

Figure 41

2. Disconnect 2 pin connectors from each other and discard ~6" section of harness that contains the barrel shaped thermistor as show in Figure 42.

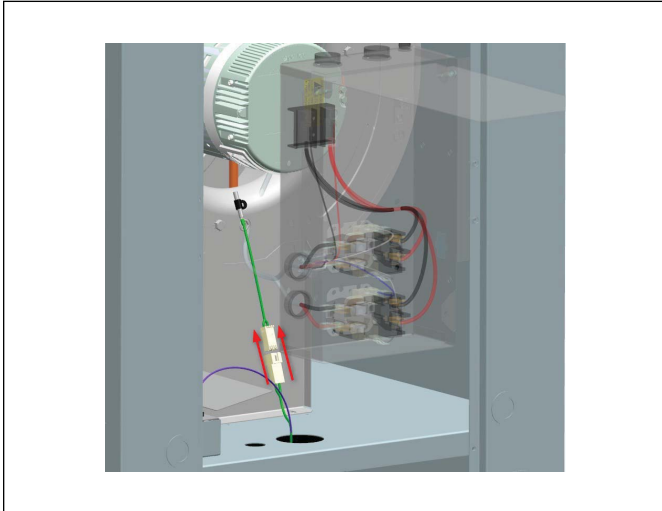

Figure 42

3. Drill 1/4" hole in center of duct work 12-18" away from unit. Using hardware provided, insert 8" discharge air temperature probed to hole and secure mounting flange to duct using hardware provided as shown in Figure 43.
4. Open knockout and route wire though hole to the remaining female interconnect and connect both pink female terminals to male blades of the interconnect as shown in Figure 44. (Figure 45 is a closer view of completed connection shown in Figure 44.)

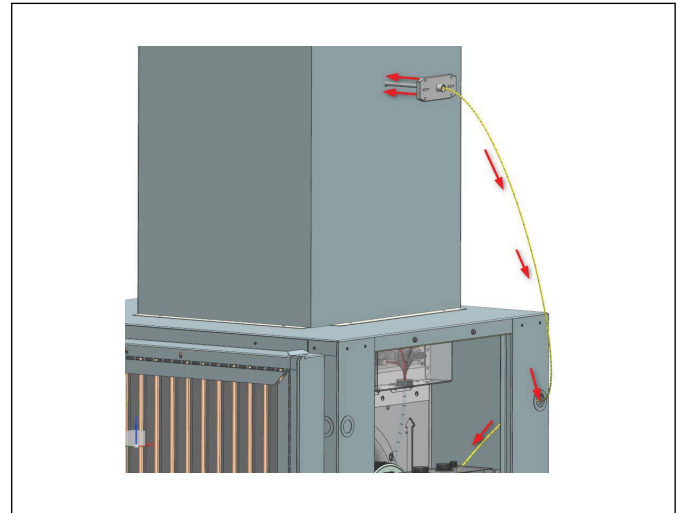

Figure 43

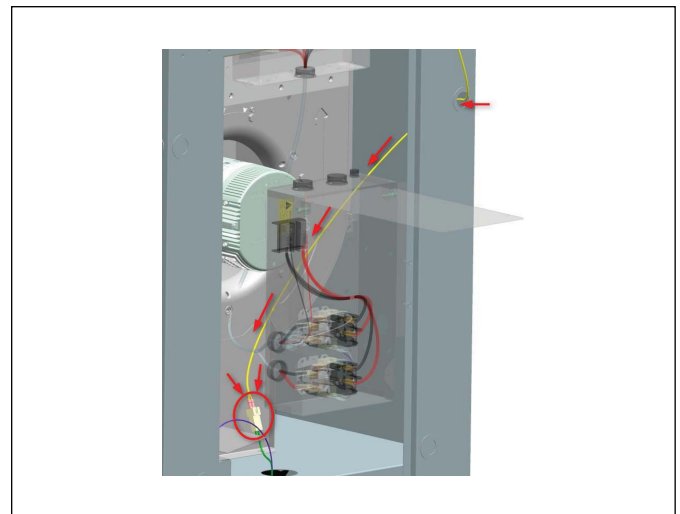

Figure 44

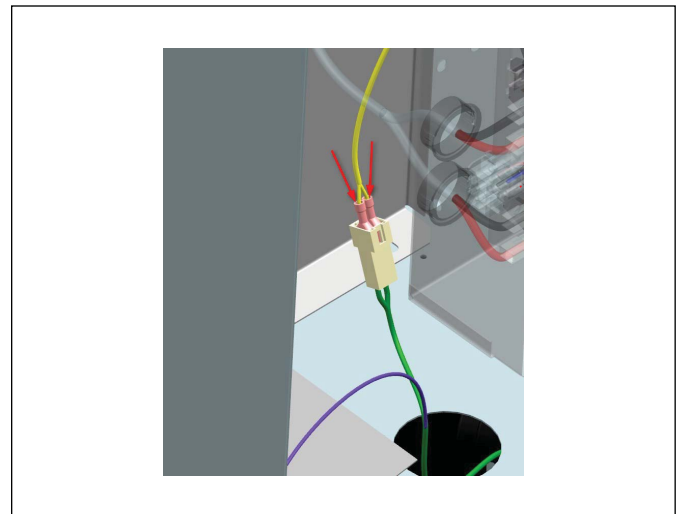

Figure 45

5.7 Field Line Voltage Connection

1. Select the appropriate wire size based upon the heater electrical load that the blower motor and electric heater element(s) will require. Refer to the data tag label that is included in the heater kit or the Electric Heat Electrical Data table #3 of this manual. Ensure that all national and local electrical codes are followed for installation, wire sizing, and breaker sizing.
2. Select the appropriate breaker size based upon the heater electrical load that the heat pump will require. Refer to the data tag label that is included in the heater kit or the Electrical Data (table #1) of this manual.
3. Route the new line voltage wiring and the ground wire from the circuit breaker panel to the heat pump.
4. Use the knockout provided in the heat pump corner post as the entry for the electrical service wiring. A plastic grommet should be used to protect the wire insulation from the metal edge of the knockout.
5. Connect one of the line voltage wires to "L1" terminal connection the other line voltage wire to "L2" terminal connection. Torque to 22in-lbs.
6. Use the ground lug provided in the heater control box to connect the field ground from the power supply.

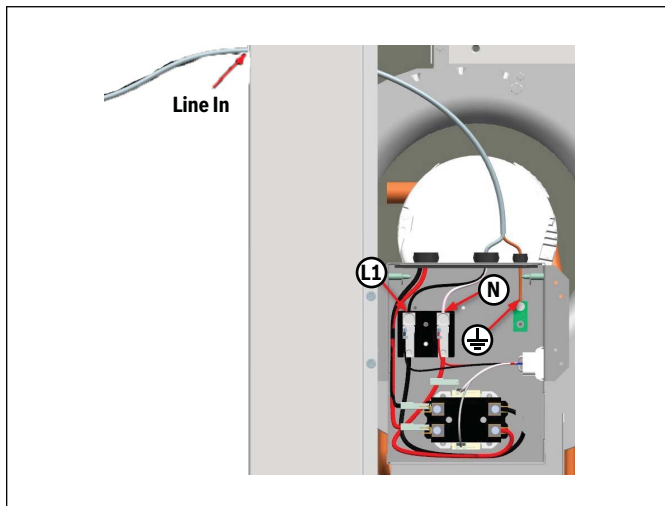

Figure 46 5kW Field Wiring - Top View

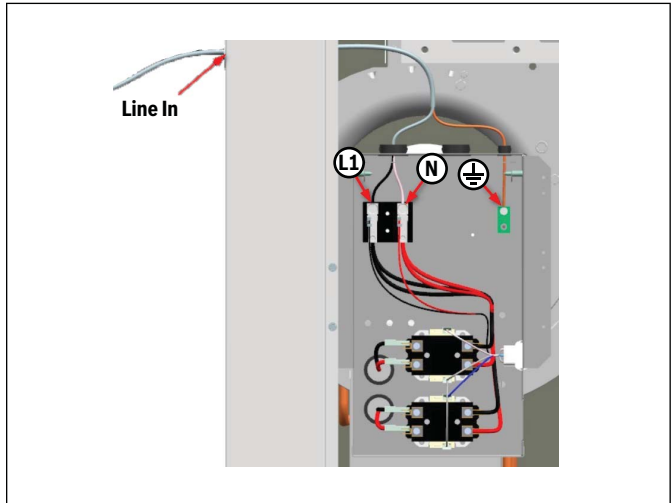

Figure 47 10kW Field Wiring - Top View

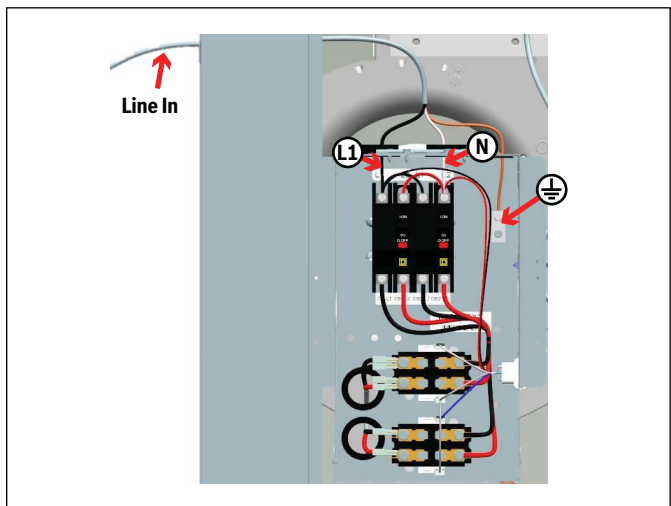

Figure 48 15kW Field Wiring - Top View

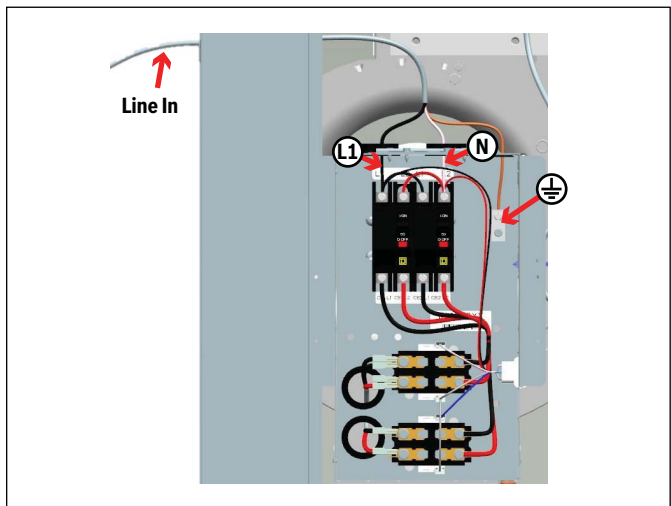

Figure 49 20kW Field Wiring - Top View

5.8 Thermostat Wire Connections

1. Please check to see if that two low voltage wires are available from the thermostat to make the “W1” and “W2” connections. If these wires are not located, they will need to be pulled and routed from the back of the thermostat to main thermostat connections on the electrical box or to the motor control board.
2. Strip the insulation off of the “W1” and “W2” wires and insert into the thermostat control wire block or on the motor control board thermostat interface. Connect the other end of the wires to the corresponding terminals on the thermostat to utilize the supplemental and emergency heat terminals.

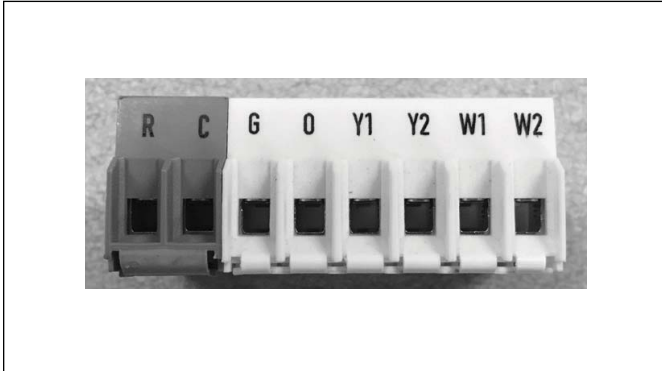

Figure 50



This drawing represents the most common wiring diagram, please refer to the thermostat or unit heat terminals. specific wiring instructions.

5.9 Wiring Diagram Replacement/Data Plate Placement

1. Remove the wiring diagram that is adhered to the back side of the front panel. Replace with the wiring diagrams included with the Heater Kit as per Table #2:

Unit Model	Replace with Diagrams P/Ns
SM EON MOTOR	8733813521 + 8733813478

Table 2

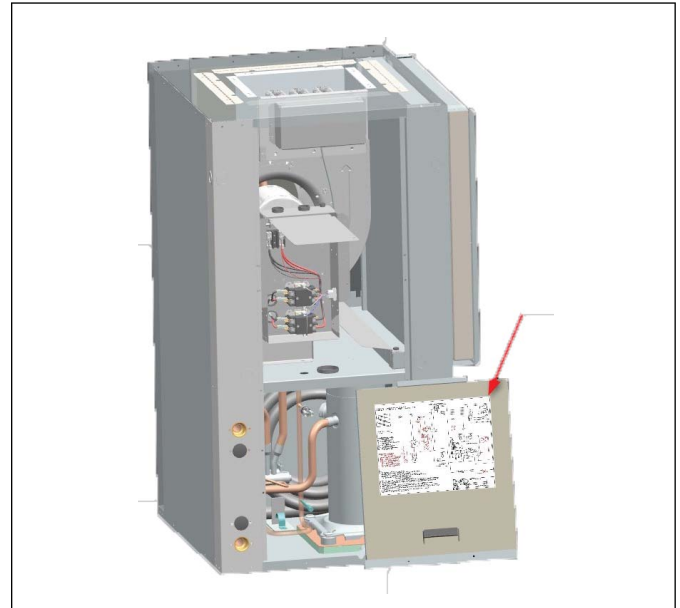

Figure 51

2. Place the adhesive backed heater data label above existing data plate label.
3. Add extra data label on outside of unit if required by local authority.

5.10 Unit Panel Reinstallation

1. Follow steps in reverse to reinstall unit panels. See Sections 5.1 and 5.2 for details.

6 Unit Start Up

1. Turn the disconnect switch or breaker switch to the "ON" position for the compressor and for the new separate circuit servicing the blower motor and the heating elements.
2. Run the unit in heating mode with the heating elements engaged for at least 10 minutes to ensure the unit does not shut down due to any temperature limiting device.

7 Information on Decommissioning

Only trained and qualified technicians are allowed to decommission and dispose of equipment following applicable requirements and local codes.

**WARNING:**

- ▶ Decommissioning of this equipment can be hazardous due to system pressure and electrical components. Only trained and qualified personnel should install, repair, or service the equipment.

Protecting the Environment

Components

Many parts in the heat pump can be fully recycled in the end of the product life. Contact your city authorities for information about the disposal of recyclable products.

Refrigerant

At the end of the service life of this appliance and prior to its environmental disposal, a person qualified to work with refrigerant circuits must recover the refrigerant from within the sealed system.



By disposing of this product correctly you will help ensure that the waste undergoes the necessary treatment, recovery and recycling, thus, preventing potential negative effects on the environment and human health which could otherwise arise due to inappropriate waste handling.

8 Electrical Data and Diagrams

Unit Model	Circuit Branches		Fan Motor		MCA 208V / 240V	MOCP 208V / 240V	Heater Element	
			HP	FLA			kW 208V / 240V	A 208V / 240V
HK050-1201	5kW Single Circuit		0.33	2.8	25.1 / 28.5	30 / 30	3.6 / 4.8	17.3 / 20
			0.5	4.1-4.3	27 / 30.4	30 / 35	—	—
			0.75	6	29.1 / 32.5	35 / 35	—	—
			0.75-1.0	6.8-7.6	31.1 / 34.5	35 / 40	—	—
			1.0	9.1	33 / 36.4	40 / 45	—	—
HK100-1201	10kW Single Circuit		0.33-0.5	2.8-4.3	48.6 / 55.4	50 / 60	7.2 / 9.6	34.6 / 40
			0.75-1.0	6.0-7.6	52.8 / 59.5	60 / 60	—	—
			1.0	9.1	54.6 / 61.4	60 / 70	—	—
HK150-1201	15kW Single Circuit		0.75-1.0	6.0-9.1	76.3 / 86.4	80 / 90	10.8 / 14.4	51.9 / 60
	15kW Dual Circuit	Ckt 1 +	0.75-1.0	6.0-7.6	52.8 / 59.5	60 / 60	7.2 / 9.6	34.6 / 40
			1.0	9.1	54.6 / 61.4	60 / 70	—	—
		Ckt 2	—	—	21.6 / 25	25 / 30	3.6 / 4.8	17.3 / 20
HK200-1201	20kW Single Circuit		0.75-1.0	6-9.1	97.9 / 111.4	100 / 125	14.4 / 19.2	69.2 / 80
	20kW Dual Circuit	Ckt 1 +	0.75-1.0	6-7.6	52.8 / 59.5	60 / 60	7.2 / 9.6	34.6 / 40
			1.0	9.1	54.6 / 61.4	60 / 70	—	—
		Ckt 2	—	—	43.3 / 50	50 / 60	7.2 / 9.6	34.6 / 40

Table 3 Electric Heat Electrical Data

1-Phase HPC EON Blower Electrical Large Box Components

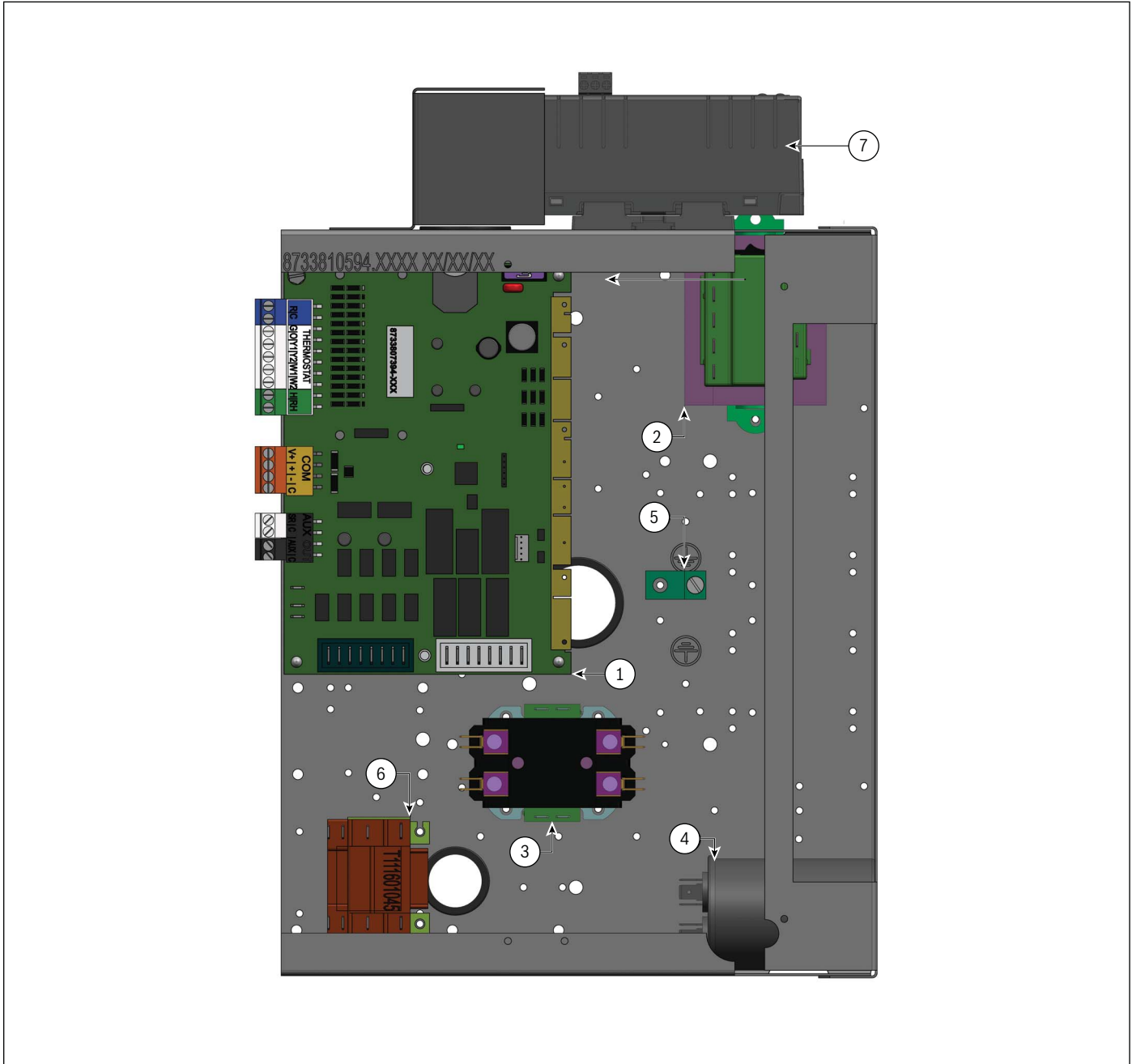
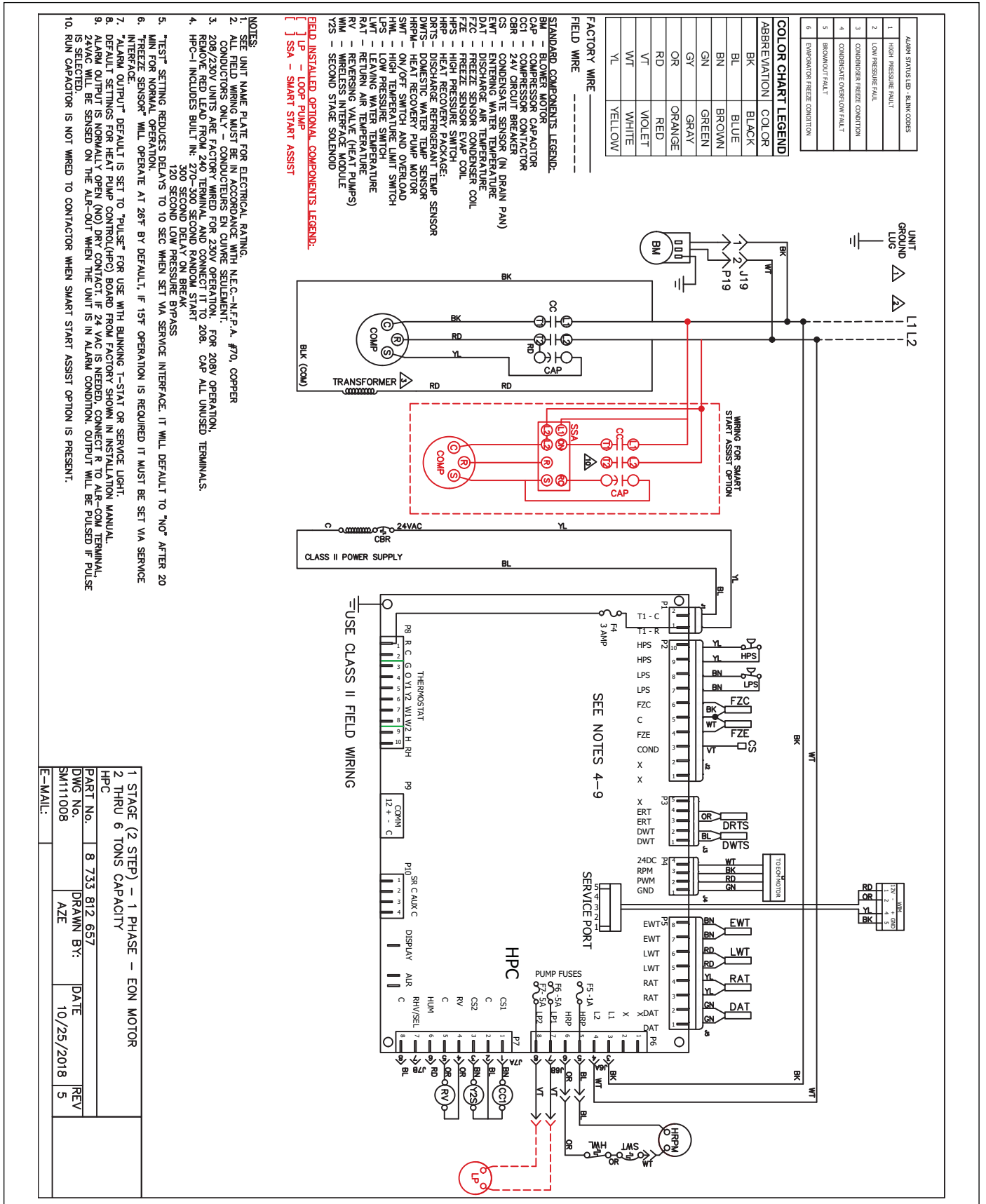

Figure 52

Components:

- [1] Heat Pump Controller
- [2] Transformer
- [3] Compressor Contactor
- [4] Compressor Capacitor
- [5] Chassis Ground Lug
- [6] Pump/Valve Relay (Field Installed)
- [7] Smart Start Assist Module (Field Installed)

Wiring Diagrams



ALARM STATUS - BLINK CODES
1 HIGH PRESSURE FAULT
2 LOW PRESSURE FAULT
3 CONDENSATE FROST CONDITION
4 CONDENSATE OVERFLOW FAULT
5 BROWNOUT FAULT
6 EVAPORATOR FROST CONDITION

FACTORY WIRE -----

COLOR CHART LEGEND	ABBREVIATION	COLOR
	BK	BLACK
	BL	BLUE
	BN	BROWN
	GN	GREEN
	GY	GRAY
	OR	ORANGE
	PL/BL	PALE BLUE
	RD	RED
	VT	VIOLET
	WT	WHITE

STANDARD COMPONENTS LEGEND:
 BM - BLOWER MOTOR
 CAP - COMPRESSOR CAPACITOR
 CBR - COMPRESSOR CONTACTOR 1
 CBR - 24V CIRCUIT BREAKER
 CS - CONDENSATE SENSOR (IN DRAIN PAN)
 EWT - ENTERING WATER TEMPERATURE
 FZC - FROST SENSOR AIR TEMPERATURE
 FZE - FROST SENSOR EVAP COIL
 FHS - HIGH PRESSURE SWITCH
 HPT - HIGH TEMPERATURE SWITCH
 DRTS - DISCHARGE REFRIGERANT TEMP SENSOR
 DWTs - DOMESTIC WATER TEMP SENSOR
 HRPM - HEAT RECOVERY PUMP MOTOR
 LPS - ON/OFF SWITCH AND OVERLOAD
 LPT - LOW PRESSURE SWITCH
 LWT - LEAVING WATER TEMPERATURE
 J10 - LEAK BACK UP HEAT INTERFACE PLUG
 J12 - ELECTRIC HEAT SIGNAL PLUG
 J19 - RETURN AIR TEMPERATURE
 RAT - RETURN AIR TEMPERATURE
 WIM - WIRELESS INTERFACE MODULE
 Y2S - SECOND STEP SOLENOID

FIELD INSTALLED OPTIONAL COMPONENTS LEGEND:
 [] LP - LOOP PUMP (FIELD INSTALLED)
 [] SSA - SMART START ASSIST (FIELD INSTALLED)

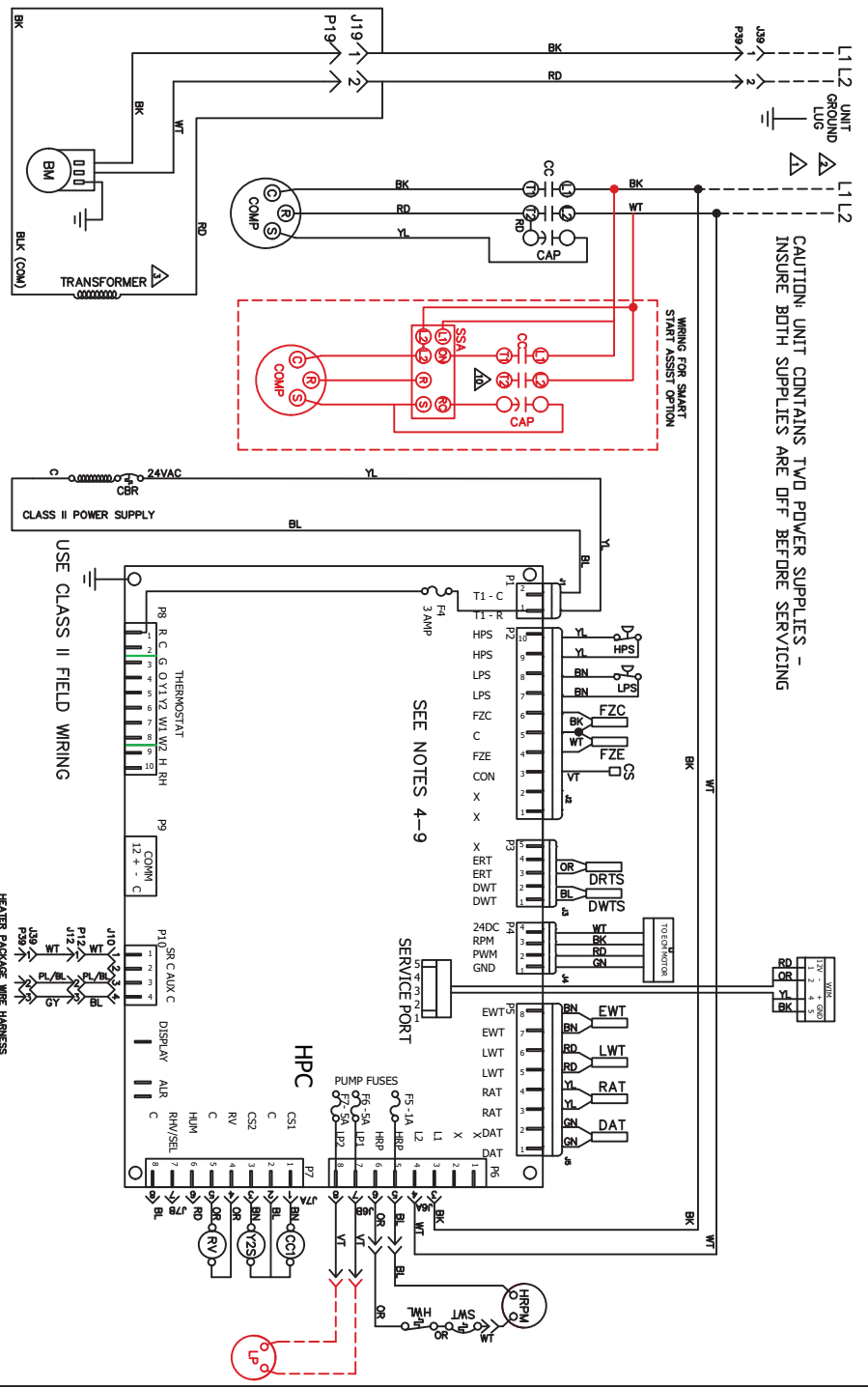

- NOTES:**
- SEE UNIT NAME PLATE FOR ELECTRICAL RATING.
 - ALL FIELD WIRING MUST BE IN ACCORDANCE WITH N.E.C.-N.F.P.A. #70, COPPER CONDUCTORS ONLY - CONDUCTORS EN CLUIVE SEULEMENT.
 - 208/230V UNITS ARE FACTORY WIRED FOR 230V OPERATION. FOR 208V OPERATION, REMOVE RED LEAD FROM 240 TERMINAL AND CONNECT IT TO 208. CAP ALL UNUSED TERMINALS.
 - HPC-1 INCLUDES BUILT IN: 230-SECOND LOW PRESSURE DELAY (NOMINAL) AND 120-SECOND LOW PRESSURE BYPASS DELAYS TO 10 SEC WHEN SET VIA SERVICE INTERFACE. IT WILL DEFAULT TO "NO" INTERFACE.
 - "FREEZE SENSOR" WILL OPERATE AT 28°F BY DEFAULT. IF 15°F OPERATION IS REQUIRED IT MUST BE SET VIA SERVICE INTERFACE.
 - "ALARM OUTPUT" DEFAULT IS SET TO "PULSE" FOR USE WITH BLINKING T-STAT OR SERVICE LIGHT.
 - DEFAULT SETTINGS FOR HEAT PUMP CONTROL(HPC) BOARD FROM FACTORY SHOWN IN INSTALLATION MANUAL.
 - ALARM OUTPUT IS NORMALLY OPEN (NO) DRY CONTACT. IF 24 VAC IS NEEDED, CONNECT R TO AIR-COM TERMINAL. 24VAC WILL BE SENSED ON THE AIR-OUT WHEN THE UNIT IS IN ALARM CONDITION. OUTPUT WILL BE PULSED IF PULSE IS SELECTED.
 - RUN CHARACTER IS NOT WIRED TO CONTACTOR WHEN SMART START ASSIST OPTION IS PRESENT.

1 STAGE (2 STEP) - 1 PHASE - EON MOTOR	
2 THRU 6 TONS CAPACITY	
HPC - ELECTRIC HEAT	
PART No.	8 733 812 658
DWG No.	SM111009
DATE	10/25/2018
REV	5
E-MAIL:	

CAUTION: UNIT CONTAINS MULTIPLE POWER SUPPLIES - MAKE SURE BOTH ARE OFF BEFORE SERVICING.

HEATER PACKAGE WIRE HARNESS PLUG CONNECTED TO MAIN CONTROL BOX
NOTE: L1 AND L2 PROVIDE POWER TO CONTROL TRANSFORMER AND BLOWER MOTOR

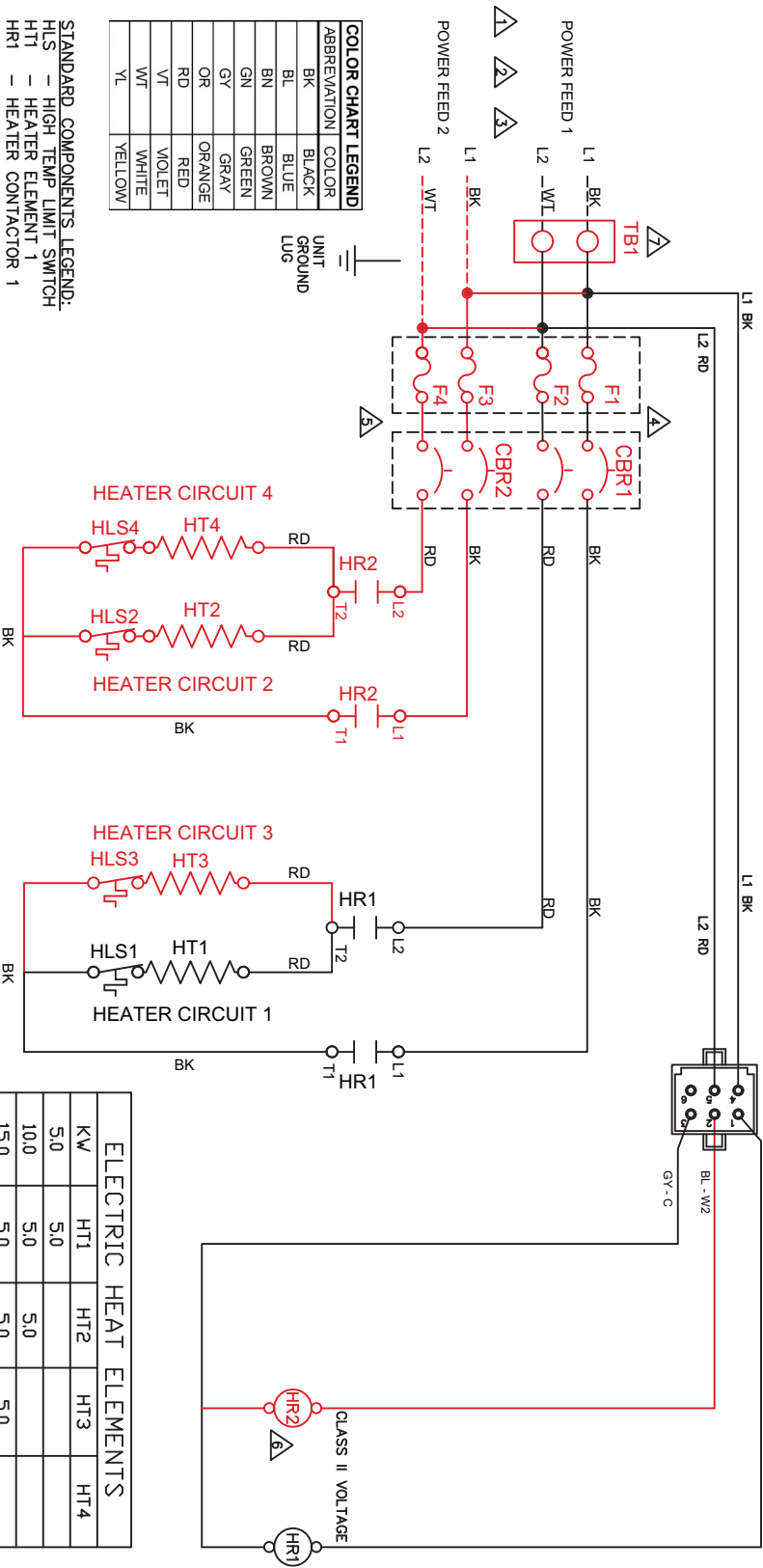

COLOR CHART LEGEND

ABBREVIATION	COLOR
BK	BLACK
BL	BLUE
BN	BROWN
GN	GREEN
GV	GRAY
OR	ORANGE
RD	RED
VT	VIOLET
WT	WHITE
YL	YELLOW

STANDARD COMPONENTS LEGEND:
 HLS - HIGH TEMP LIMIT SWITCH
 HT1 - HEATER ELEMENT 1
 HR1 - HEATER CONTACTOR 1

OPTIONAL COMPONENTS LEGEND:
 [] CBR - CIRCUIT BREAKERS (1-2)
 [] F1-4 - FUSES (1-4)
 [] HR2 - HEATER CONTACTOR 2
 [] HT2-4 - HEATER ELEMENT (2 - 4)
 [] TB1 - POWER TERMINAL BLOCK

ELECTRIC HEAT ELEMENTS

KW	HT1	HT2	HT3	HT4
5.0	5.0	5.0		
10.0	5.0	5.0		
15.0	5.0	5.0	5.0	
20.0	5.0	5.0	5.0	5.0

--- DENOTES FIELD TERMINATED COMPONENTS
 --- DENOTES OPTIONAL WIRING

- NOTES**
- SEE UNIT NAME PLATE FOR ELECTRICAL RATING
 - ALL FIELD WIRING MUST BE IN ACCORDANCE WITH NEC - NFPA 70. USE COPPER
 - CONDUCTORS ONLY - CONDUCTEURS EN CUIVRE SEULEMENT.
 - 208/230V UNITS ARE FACTORY WIRED FOR 230V OPERATION. FOR 208V OPERATION, REMOVE LEAD AND CONNECT IT ON 208 LABELED TERMINAL. CAP ALL UNUSED TERMINALS.
 - ONLY HEATERS 15 - 20 KW ARE FUSED OR HAVE CIRCUIT BREAKERS. NO UNIT WILL HAVE BOTH AT THE SAME TIME.
 - UNITS EQUIPPED WITH FUSES USE ONE-TIME CLASS K5 FUSES RATED AT 250VAC 30A FOR 15KW AND 60A FOR 20KW HEATER PACKAGES.
 - THERMOSTATS USING W2/E AS EMERGENCY HEAT SIGNAL MUST TERMINATE BLUE W2 WIRE ON HR1 COIL FOR 5KW UNITS.
 - TERMINAL BLOCK USED ON 5KW/10KW UNITS ONLY.

ELECTRIC HEAT

2 THRU 6 TONS CAPACITY	
UPM 1 - PHDENIX	
PART No. 8 733 813 521	DATE
DWG No. HE100004	9/20/2016
DRAWN BY: AZE	REV 2
E-MAIL:	

United States

**Bosch Thermotechnology Corp.
65 Grove Street
Watertown, MA 02472**

**Tel: 866-642-3198
Fax: 603-965-7581
www.boschheatingandcooling.com**